

FIG. 1



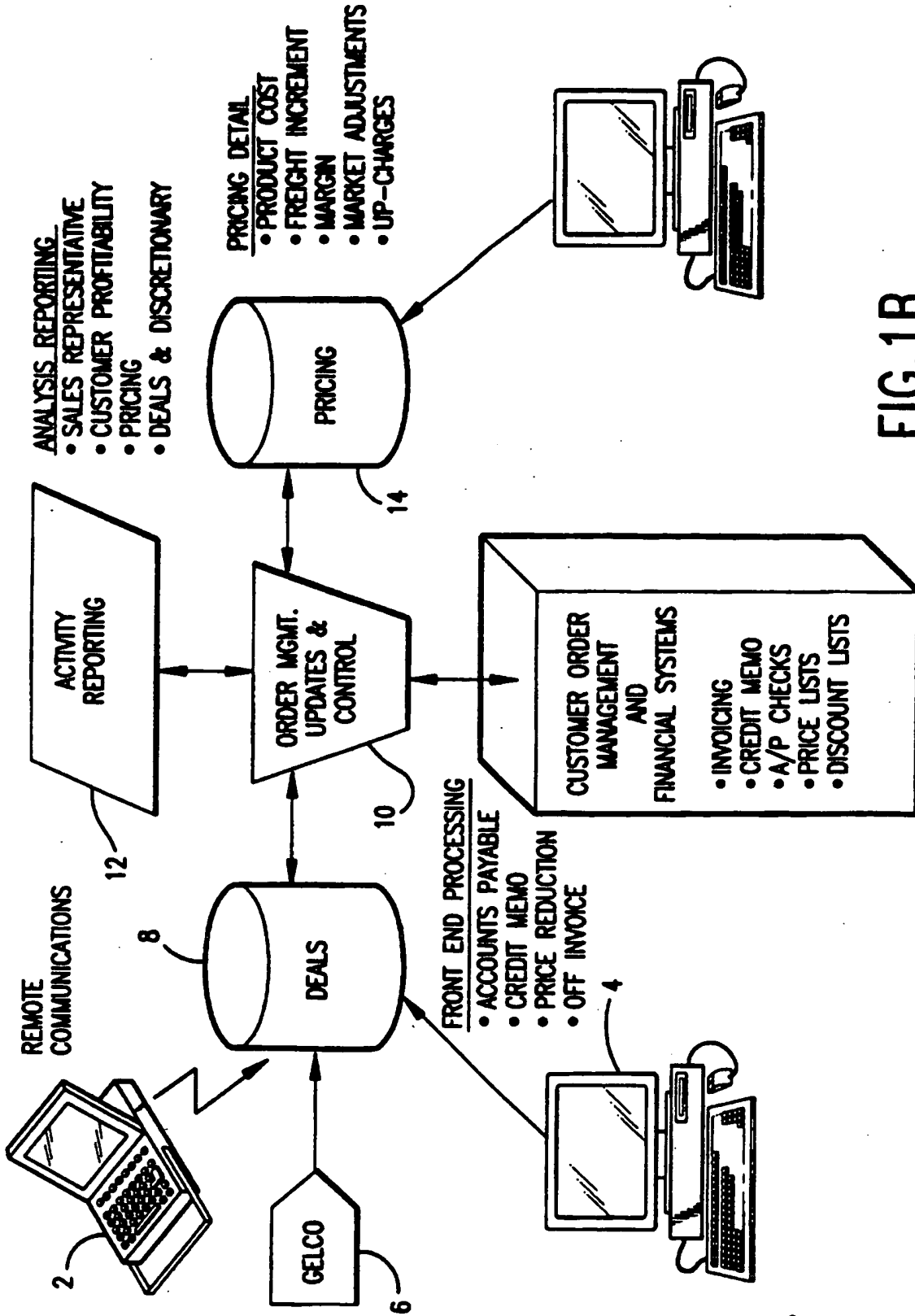

FIG.1B

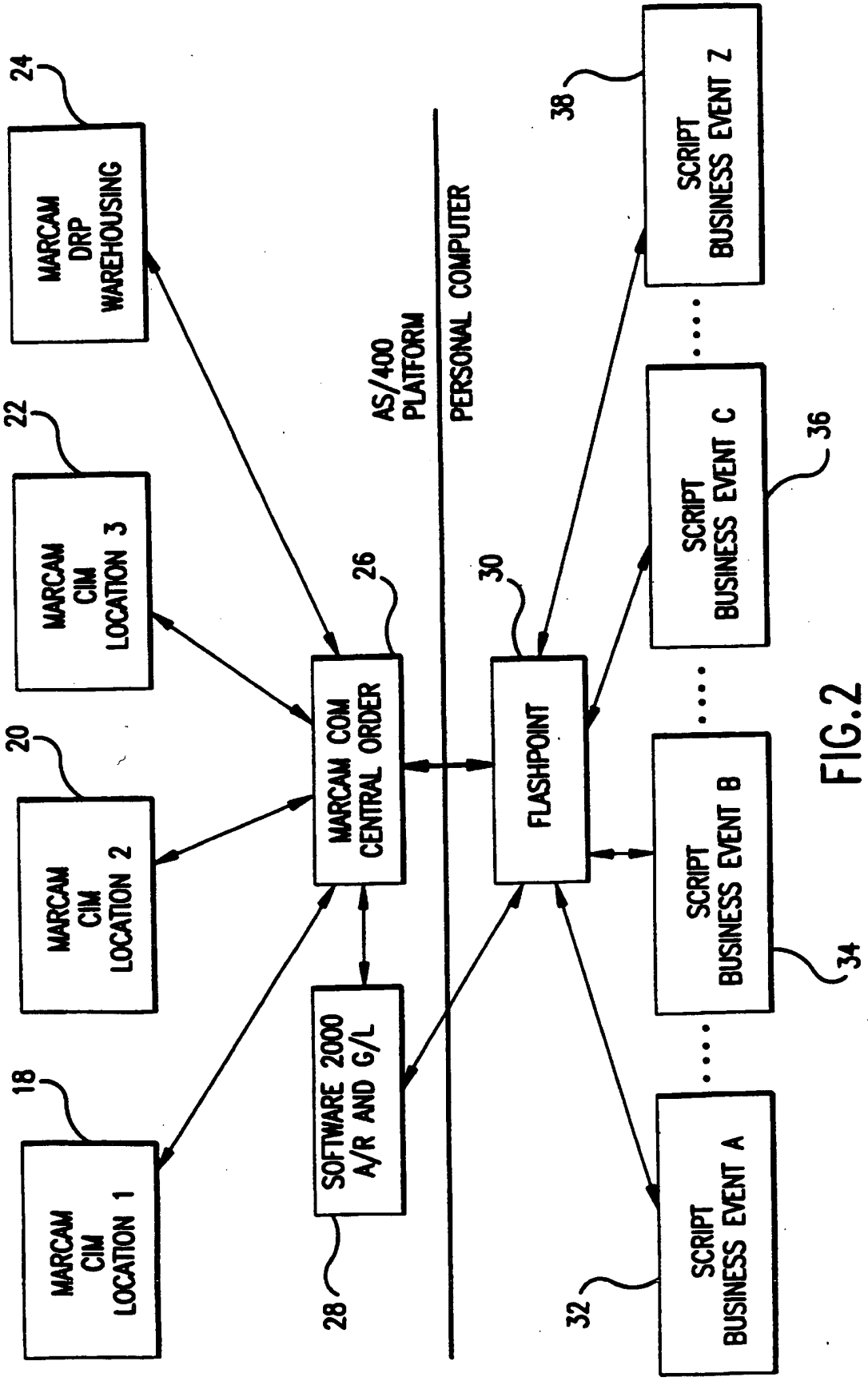

FIG. 2

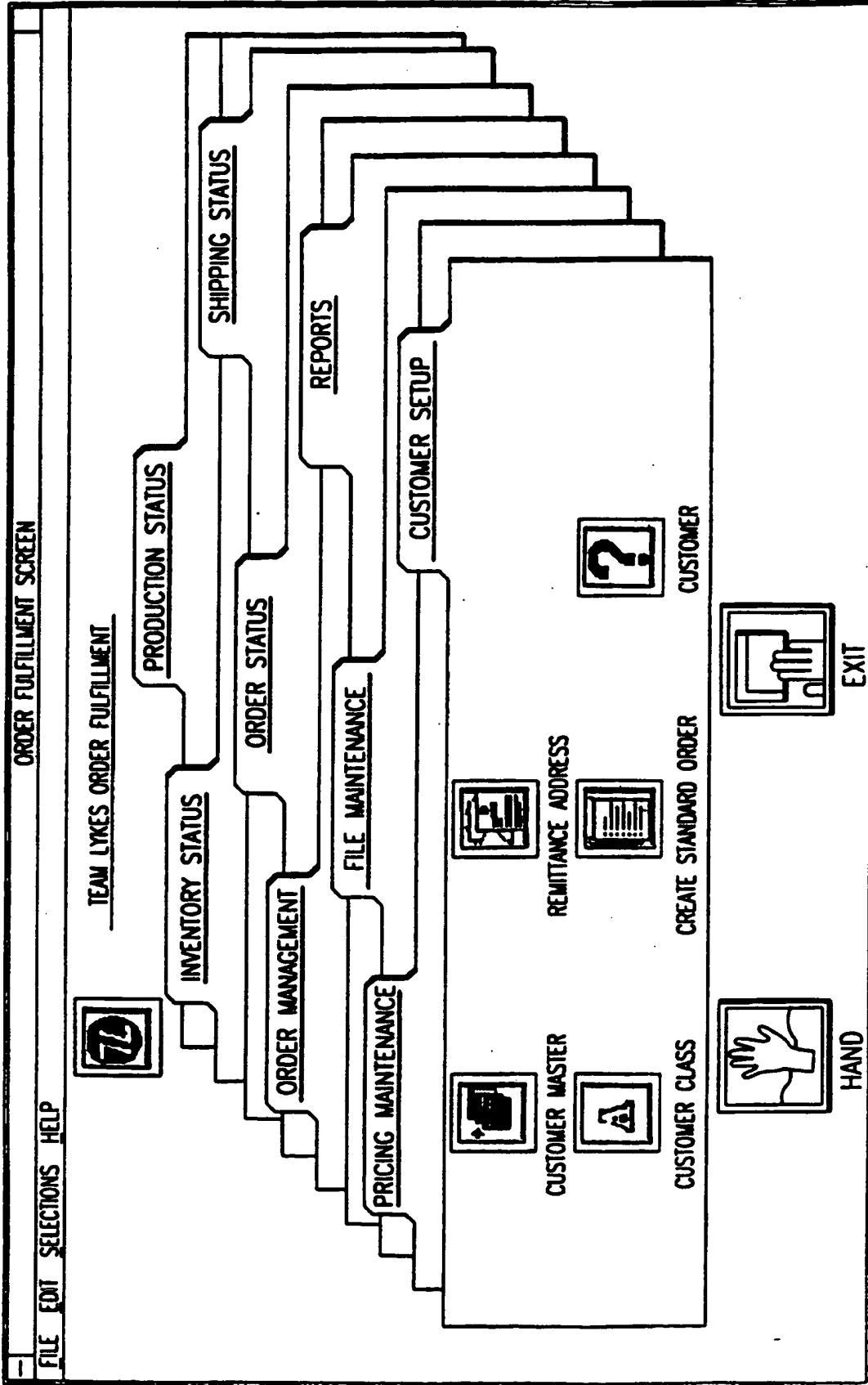

FIG.3

FILE EDIT SELECTIONS HELP

CUSTOMISEL

CUSTOMER MASTER FILE MAINTENANCE SELECTION

ENTER COMPANY NUMBER

ENTER CUSTOMER NUMBER

CUSTOMER TYPE

- SOLD TO
- SHIP TO ON

ACTION CODE

- ADD
- CHANGE
- DELETE

40

SELECT SCREEN TYPE

- SHIP TO I
- SOLD TO I
- SHIP TO II
- SOLD TO II
- SHIP TO III
- CONTACT NAMES

44

CUSTOMER ALPHA SEARCH

OK

EXIT

HELP

FIG.4

FILE EDIT SELECTIONS HELP ORDER FULFILLMENT SCREEN

ARDCUM1 PAGE

MANTAIN CUSTOMER MASTER CONTROLS

999999  ACTIVE

USO

CUSTOMER NUMBER 999999

HOME ?????

NAME LYKES RECREATIONAL DATA CENTER

ADDRESS HIGHWAY 54 EAST

CITY ZEPHYRILLS

POSTAL CODE 22532

TELEPHONE 131326541

ALIAS

NATINAL ACCOUNT

PARENT (CO/CUSTOMER)

TAX ID

SALES LEVEL ID

SALESPERSON CODE

LOCKBOX NUMBER

STATEMENT DESTINATION

STATE  FL COUNTY

FAX 1321326541

STATEMENT ORDER

46  BILL TO

48  SHIP TO

OK CANCEL EXIT

FIG.5





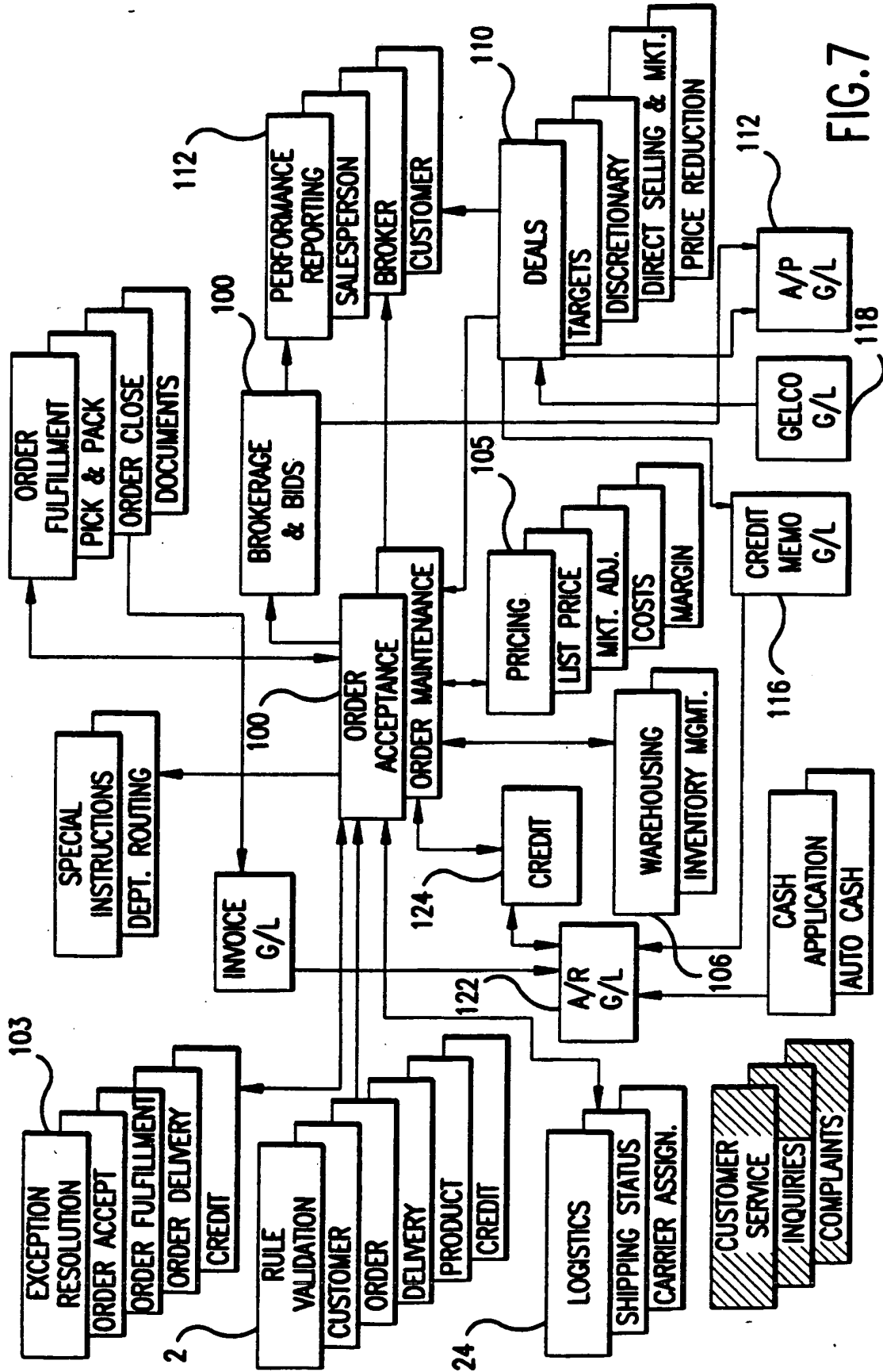

FIG. 7

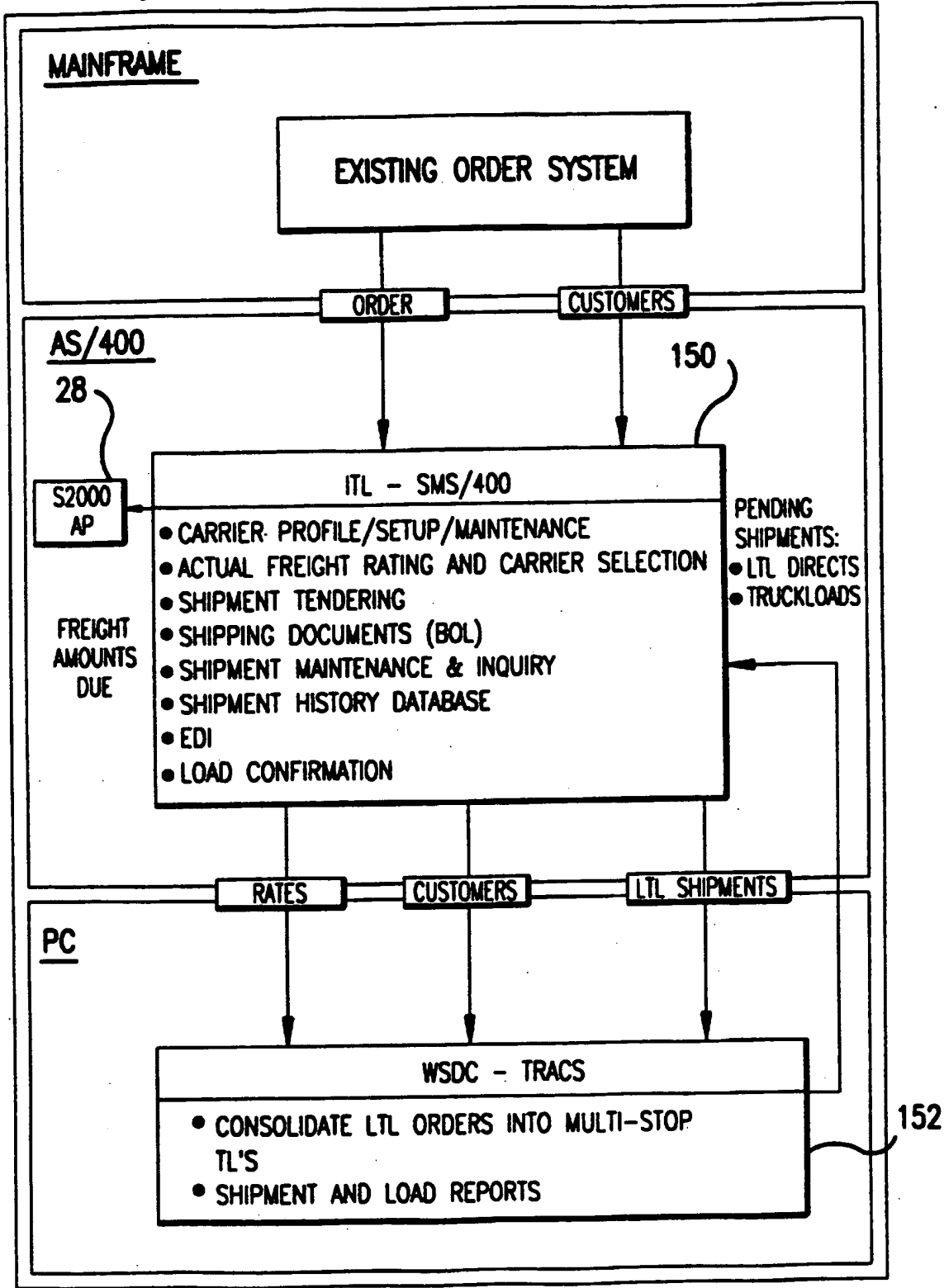

FIG.8

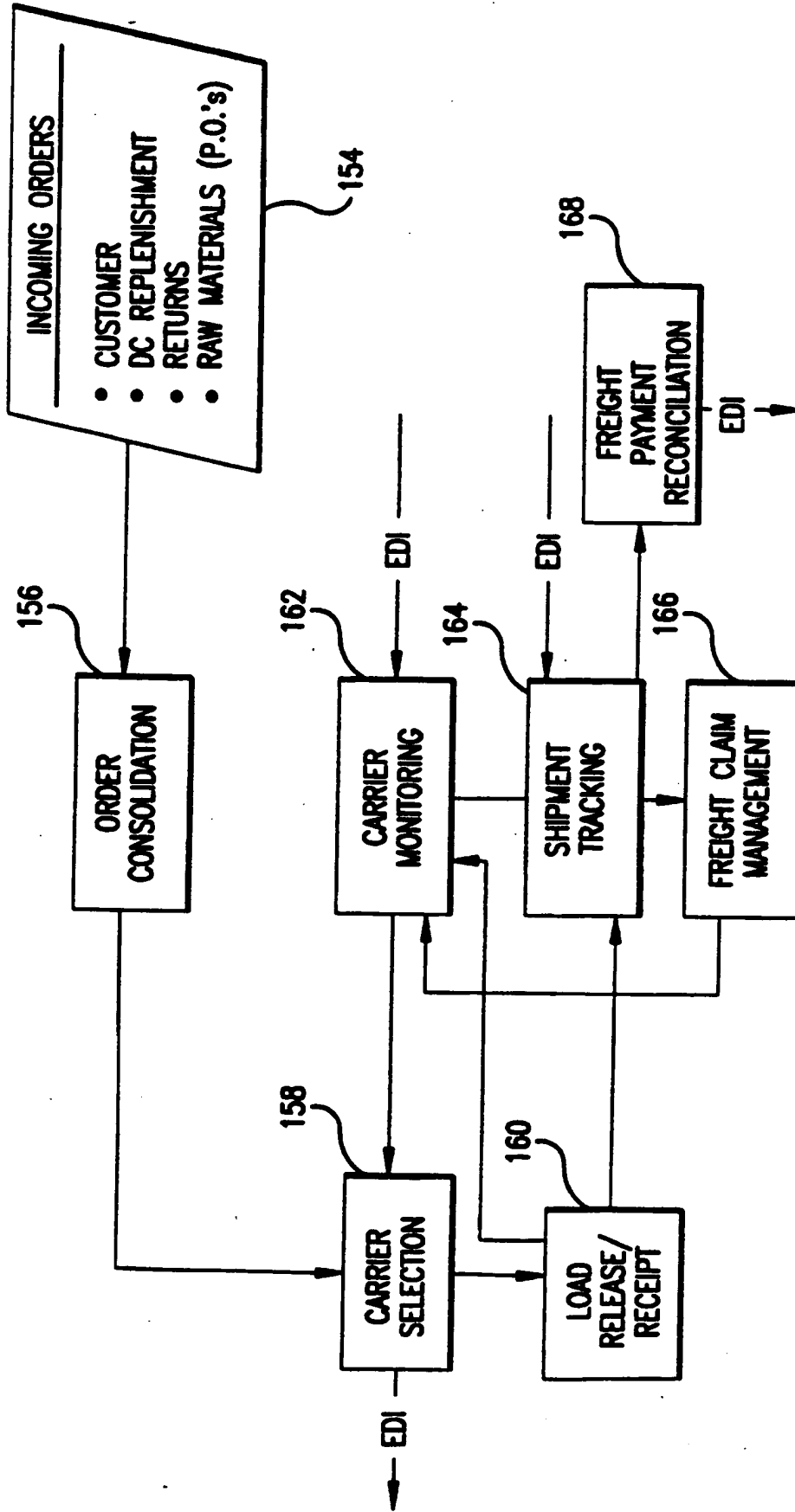

FIG. 9

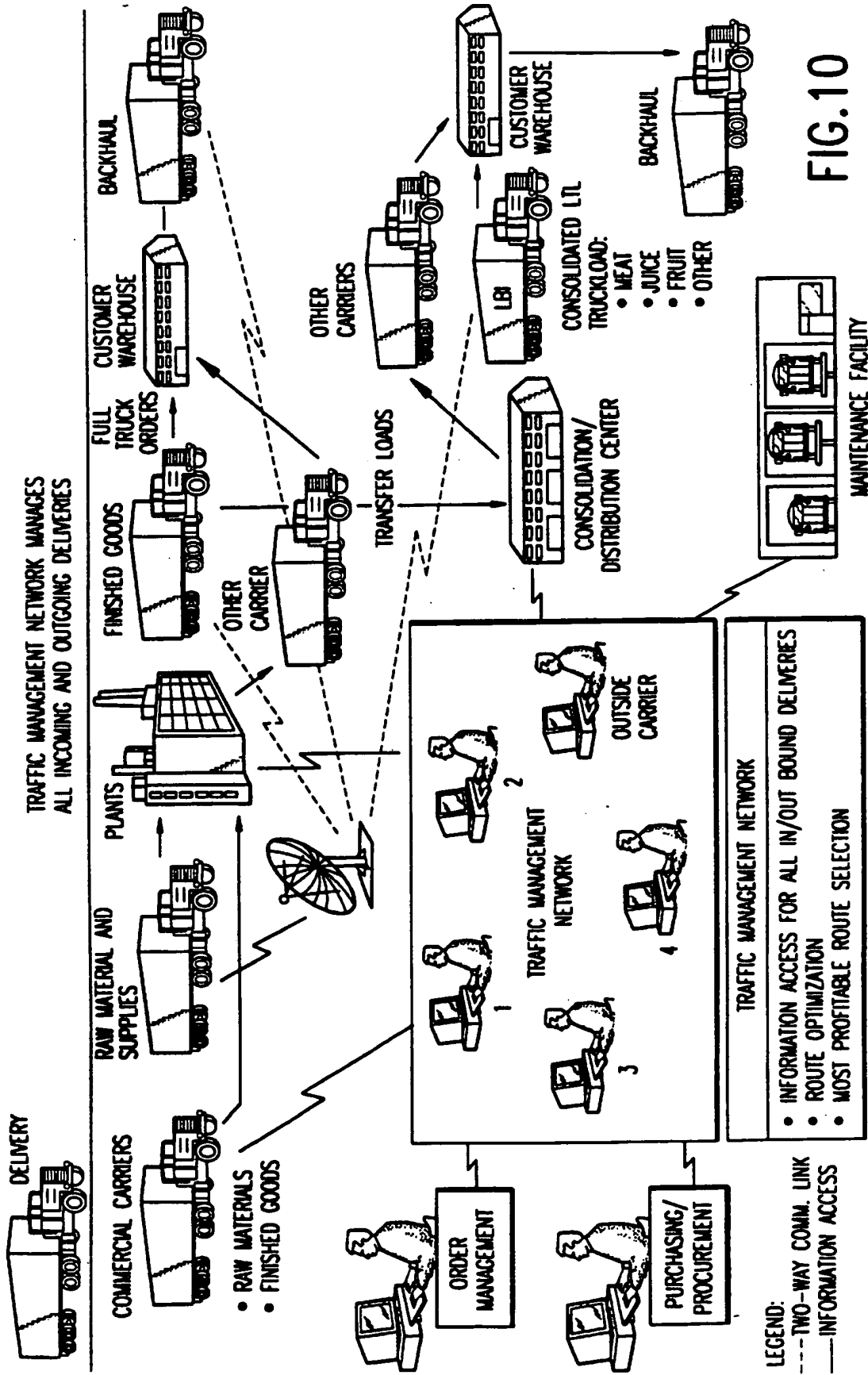

FIG.10

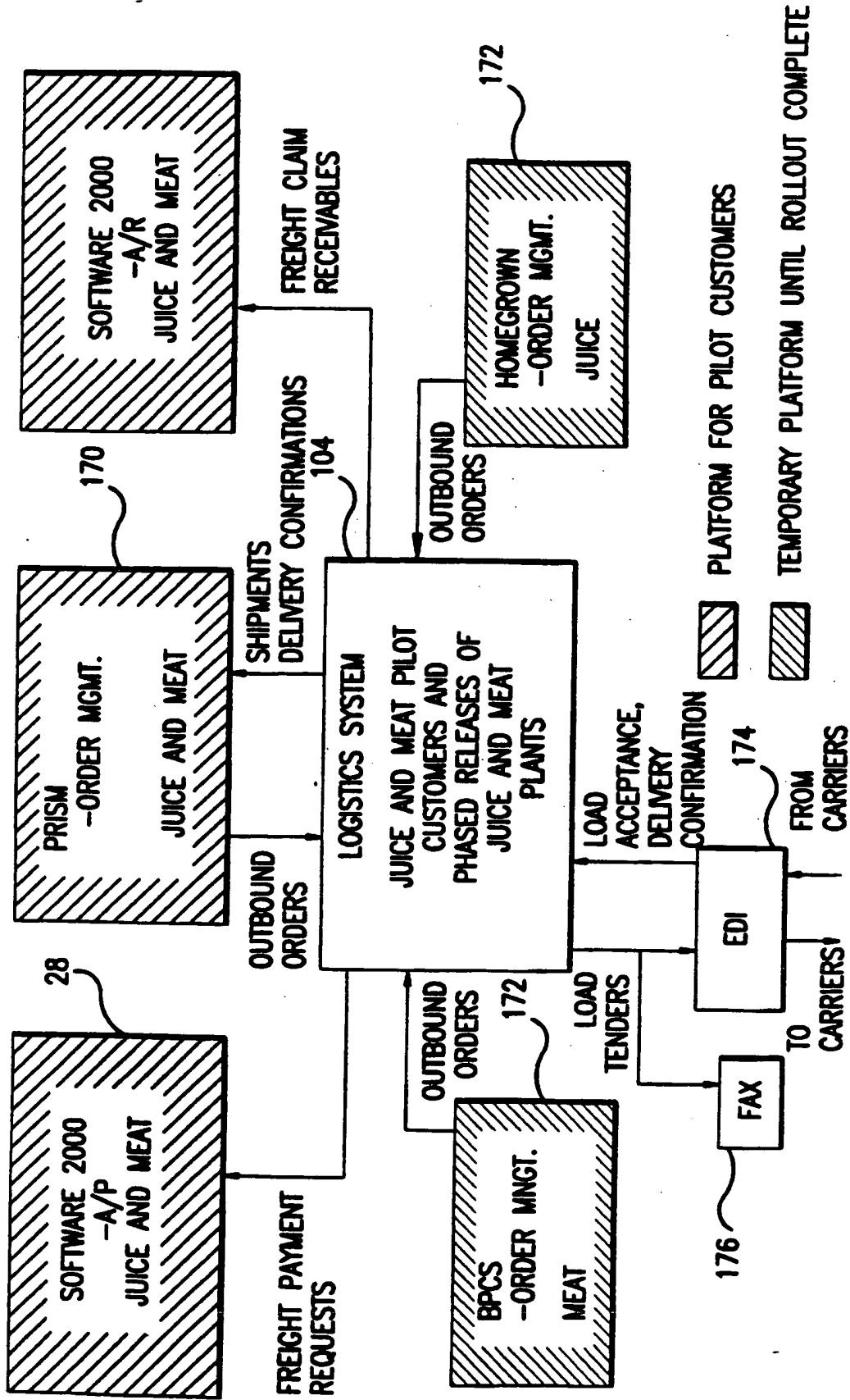

FIG.11

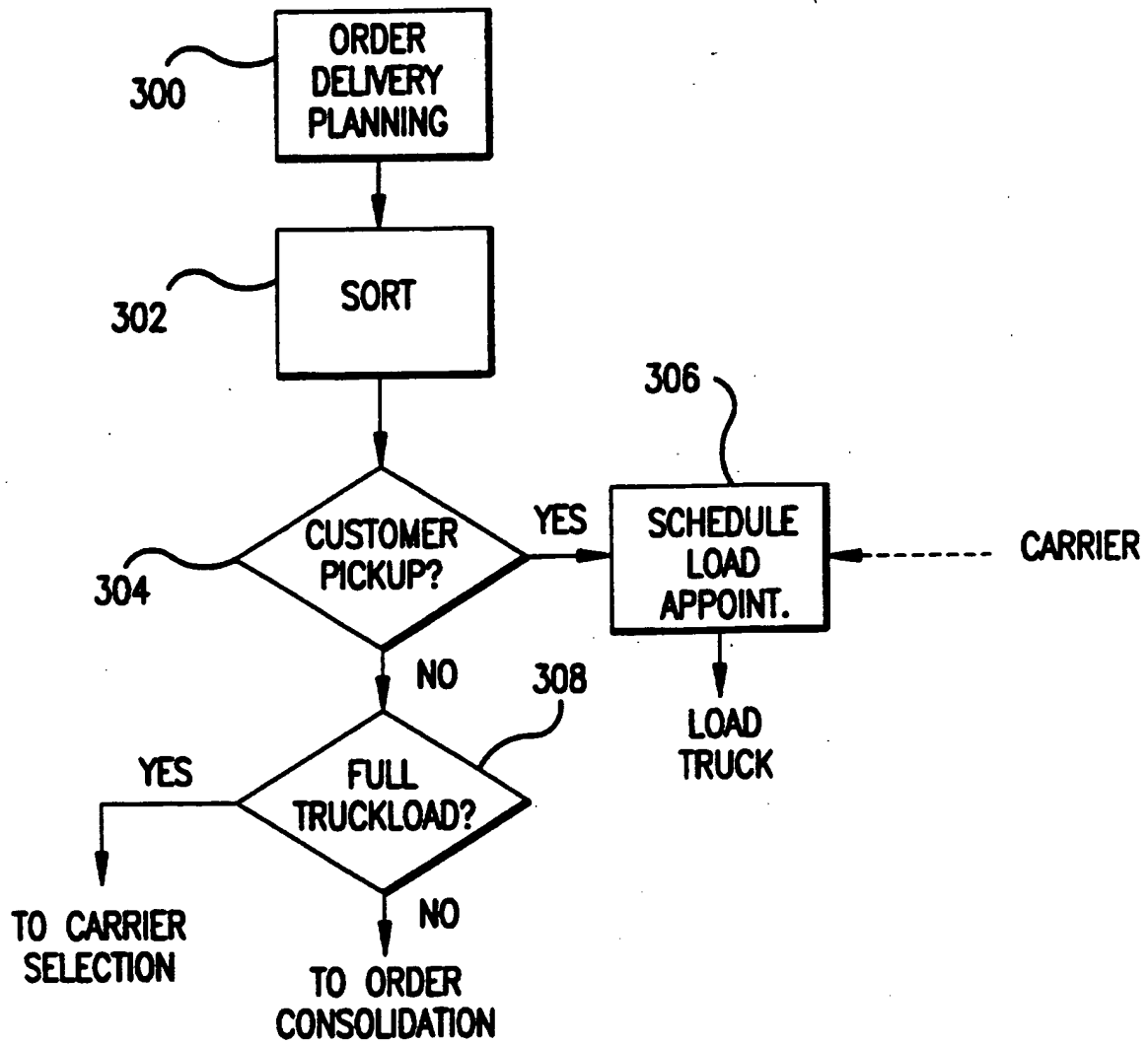

FIG.12

06100 T06000

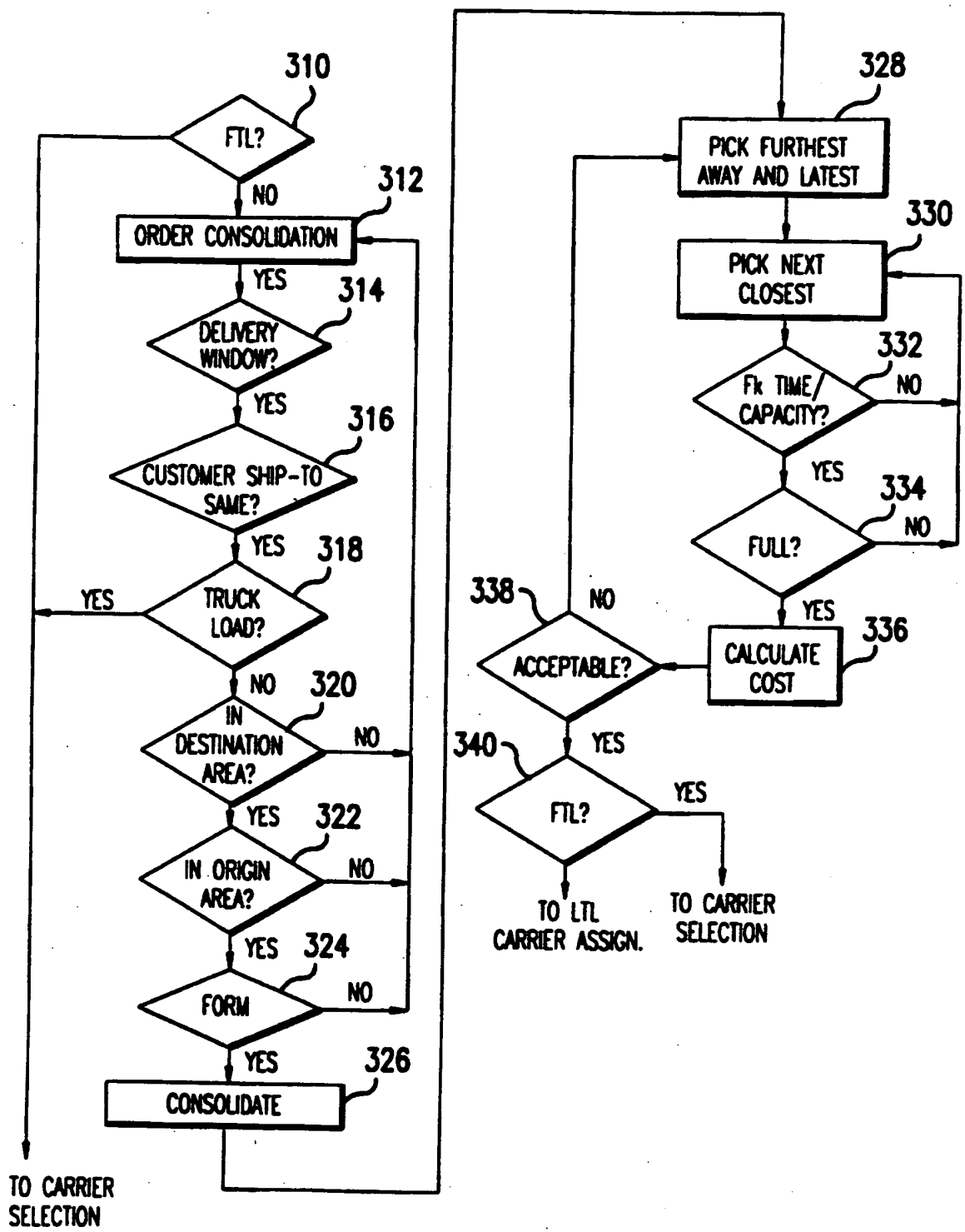

FIG.13

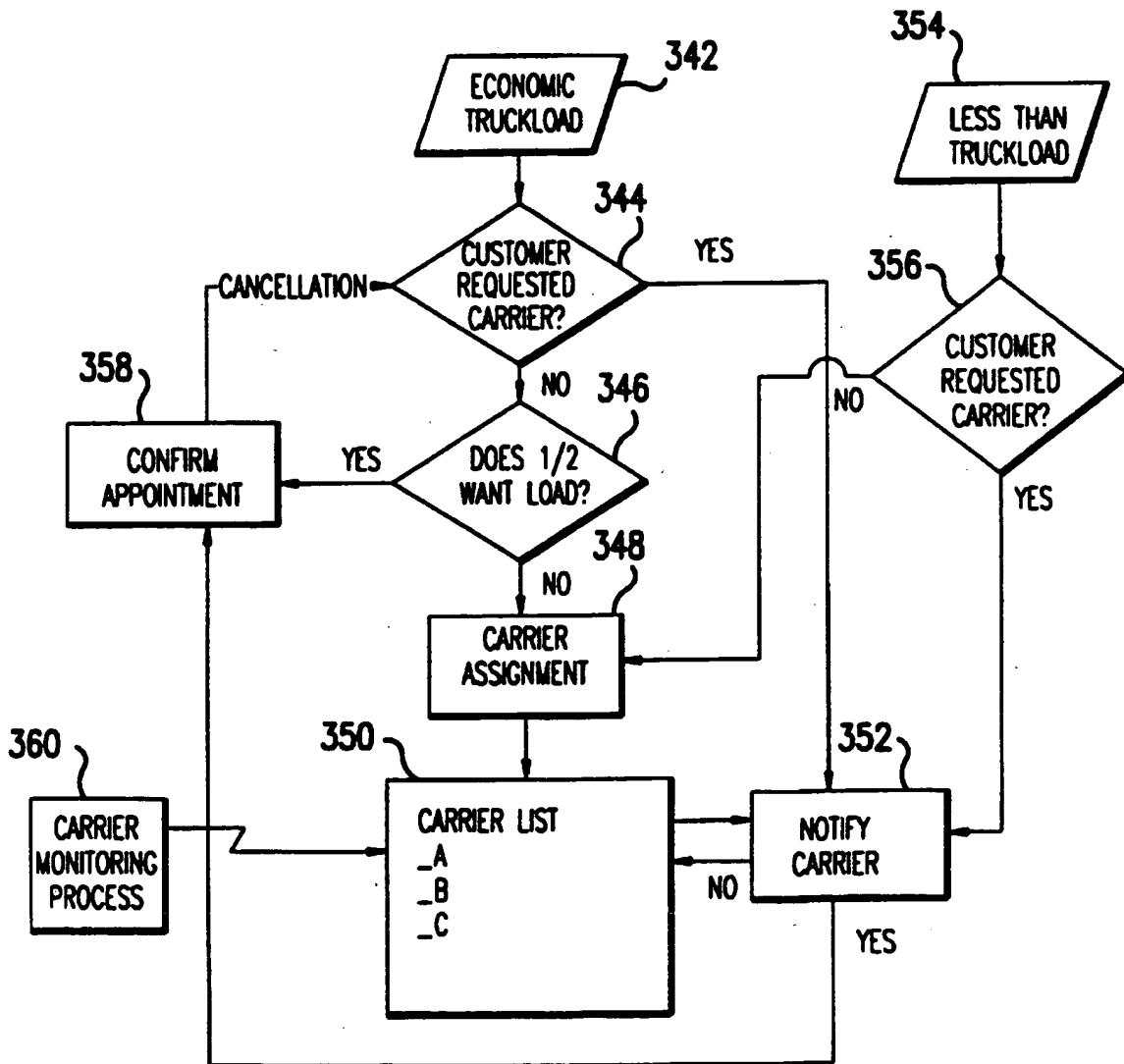

FIG.14

2025 RELEASE UNDER E.O. 14176



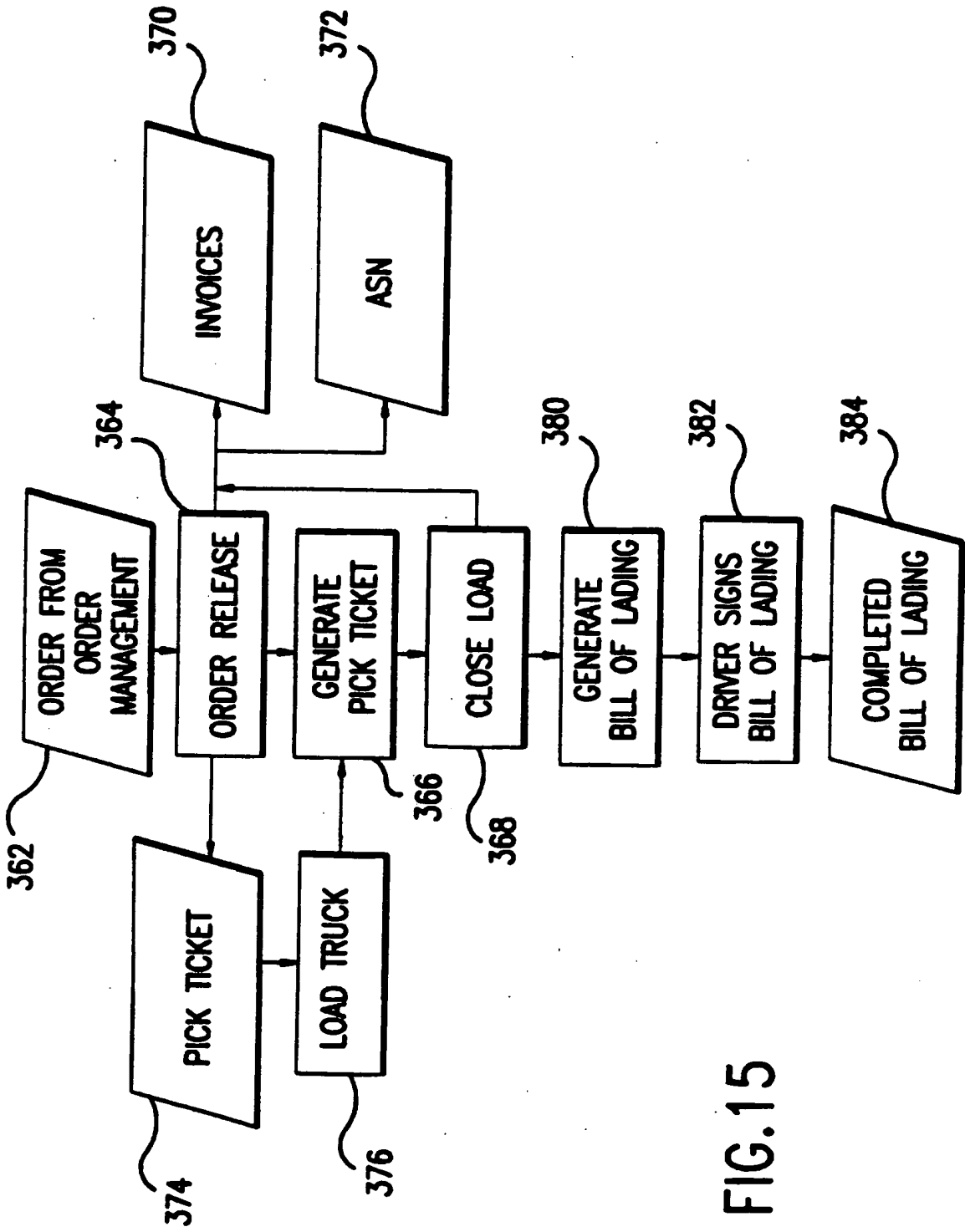

FIG.15

552007 733333

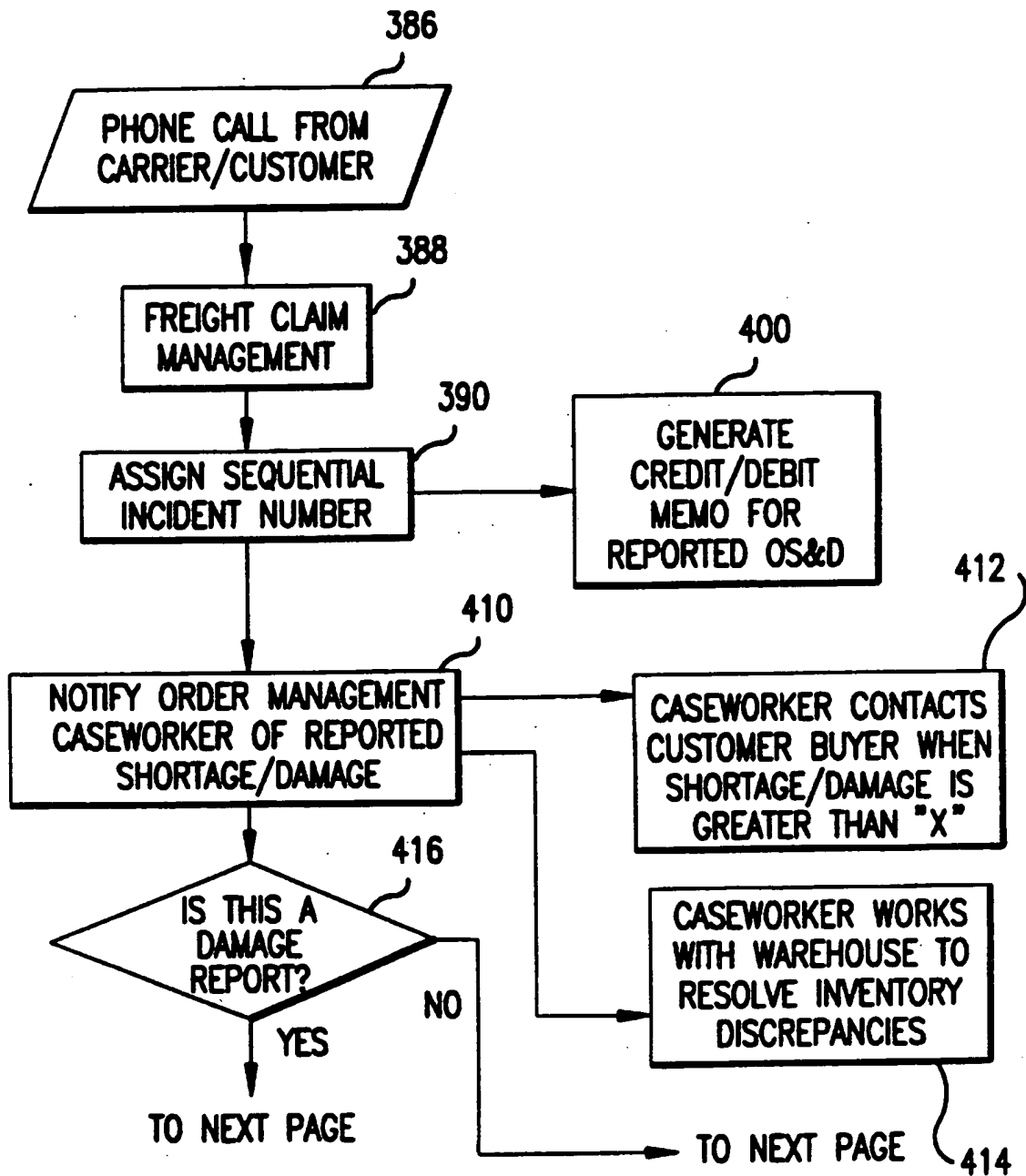

FIG. 16



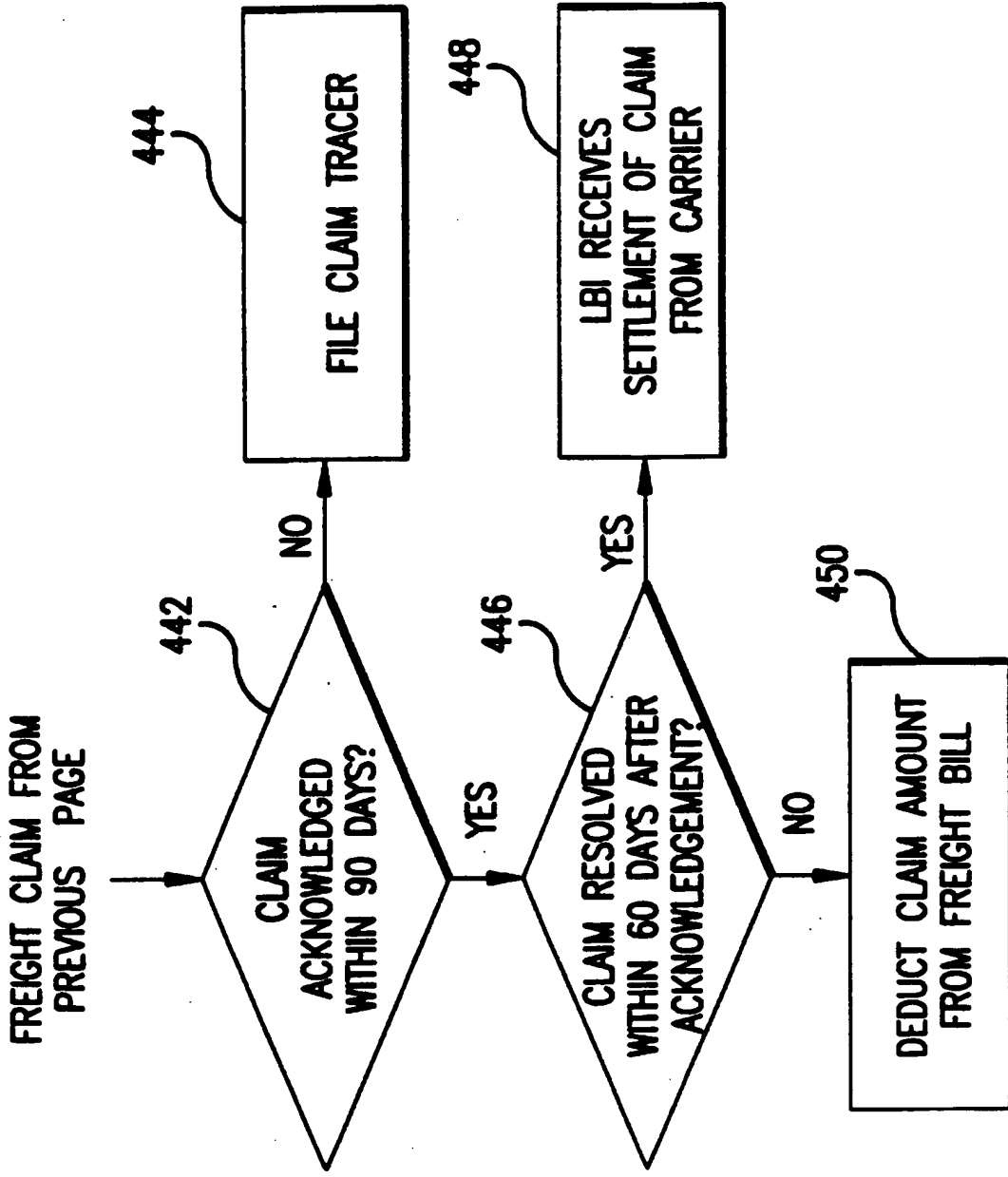

FIG.18



2025 RELEASE UNDER E.O. 14176

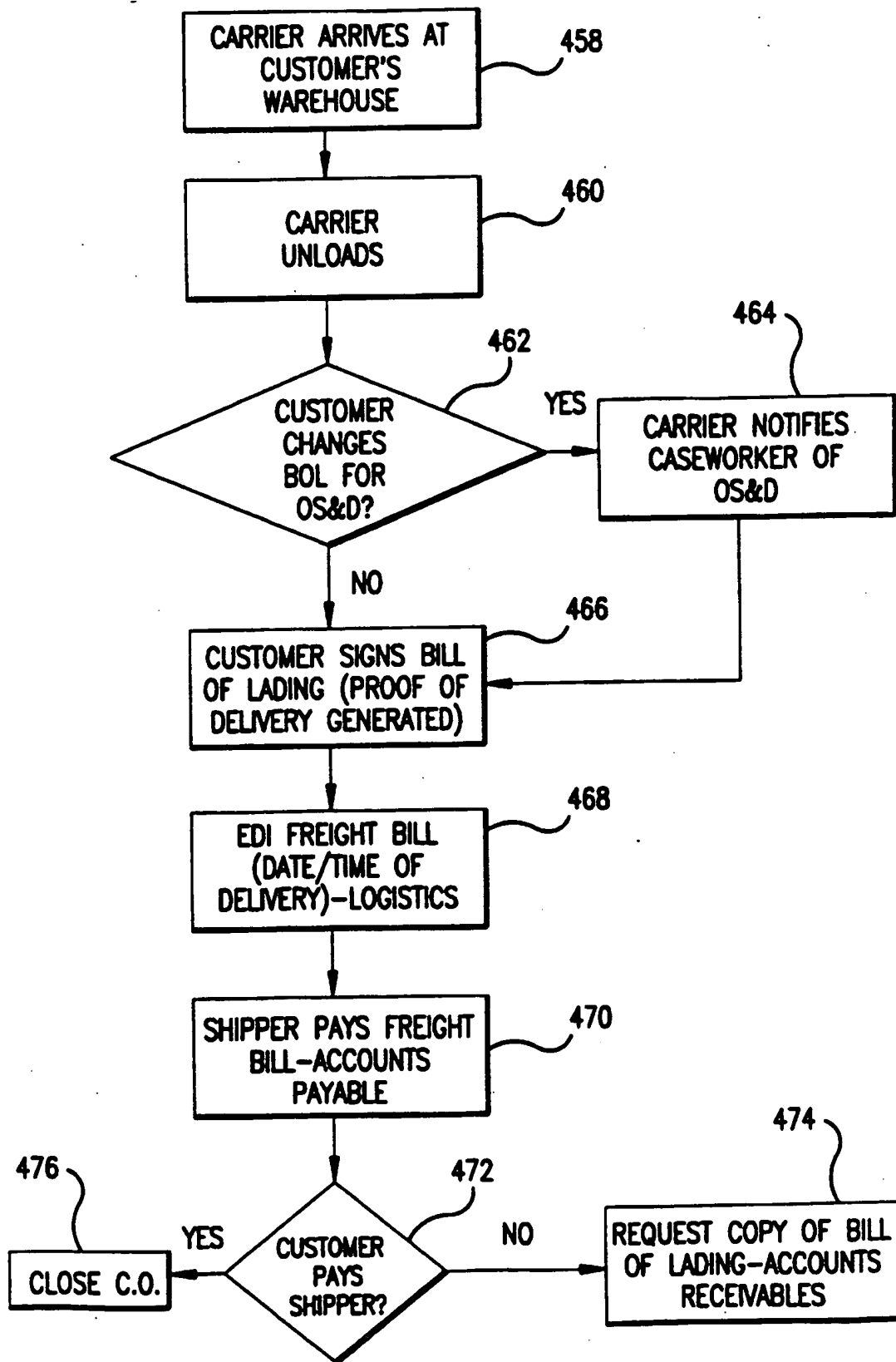

FIG. 20

6526677 00000000

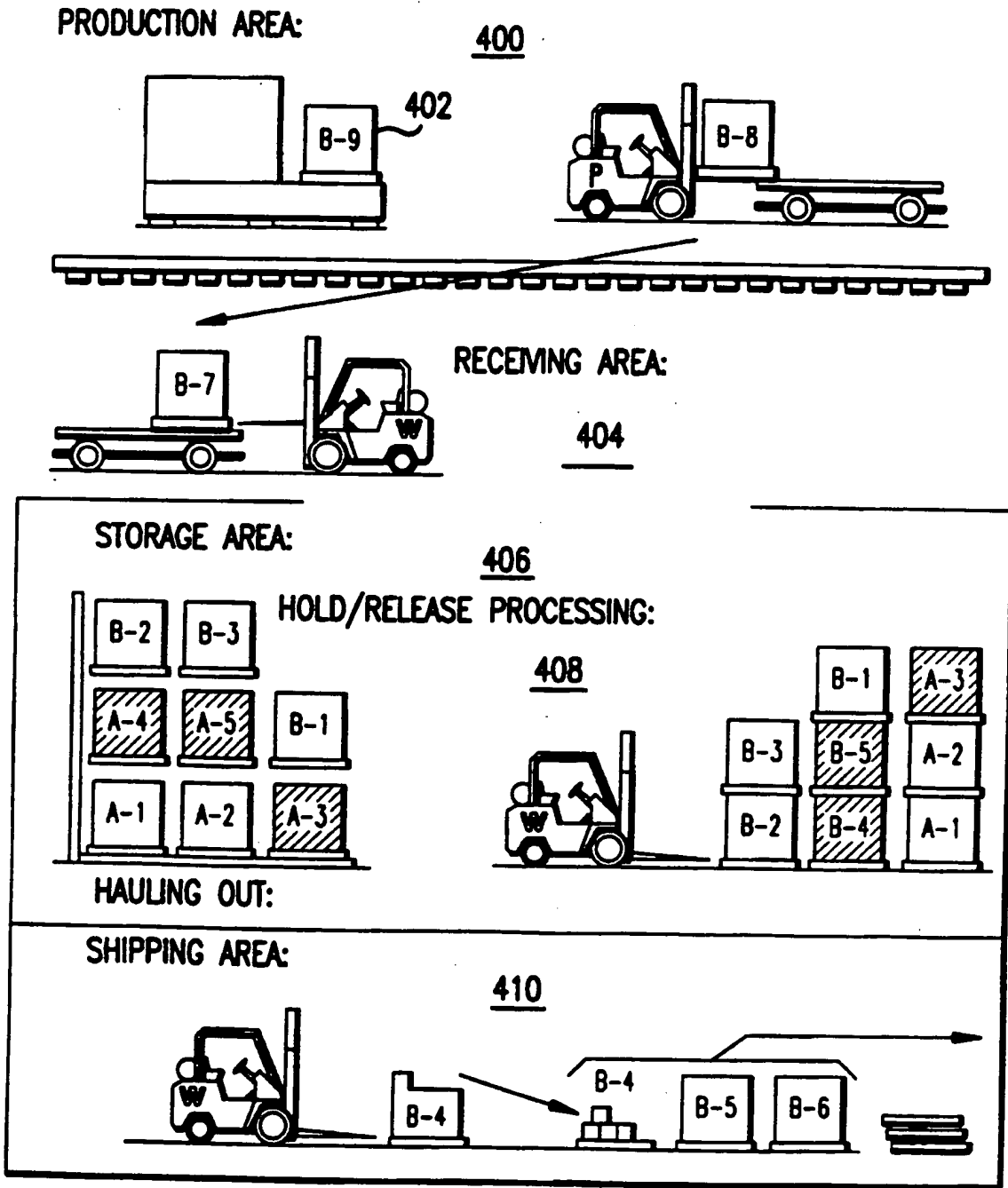

FIG.21





06222007 43233333

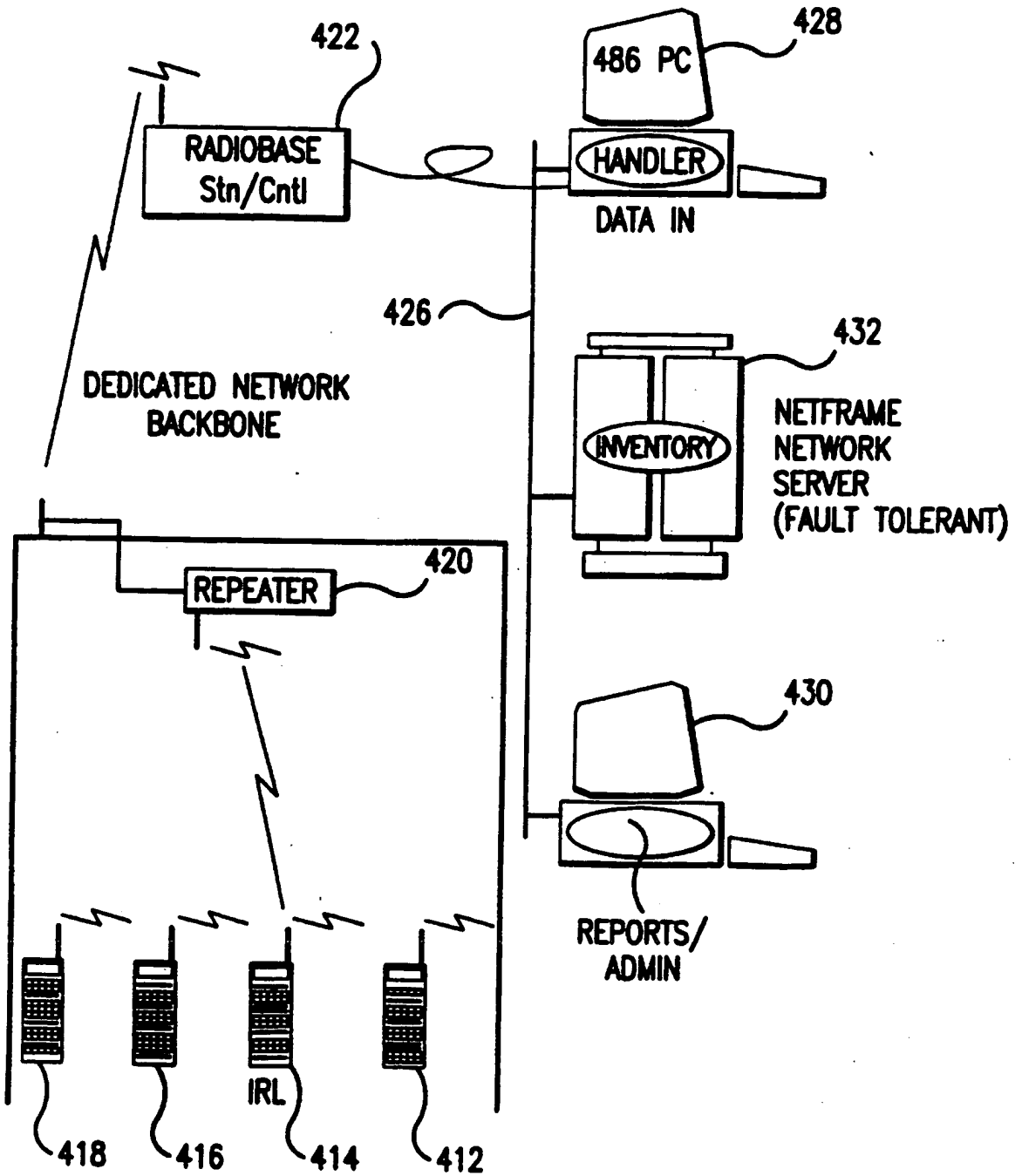

FIG.23

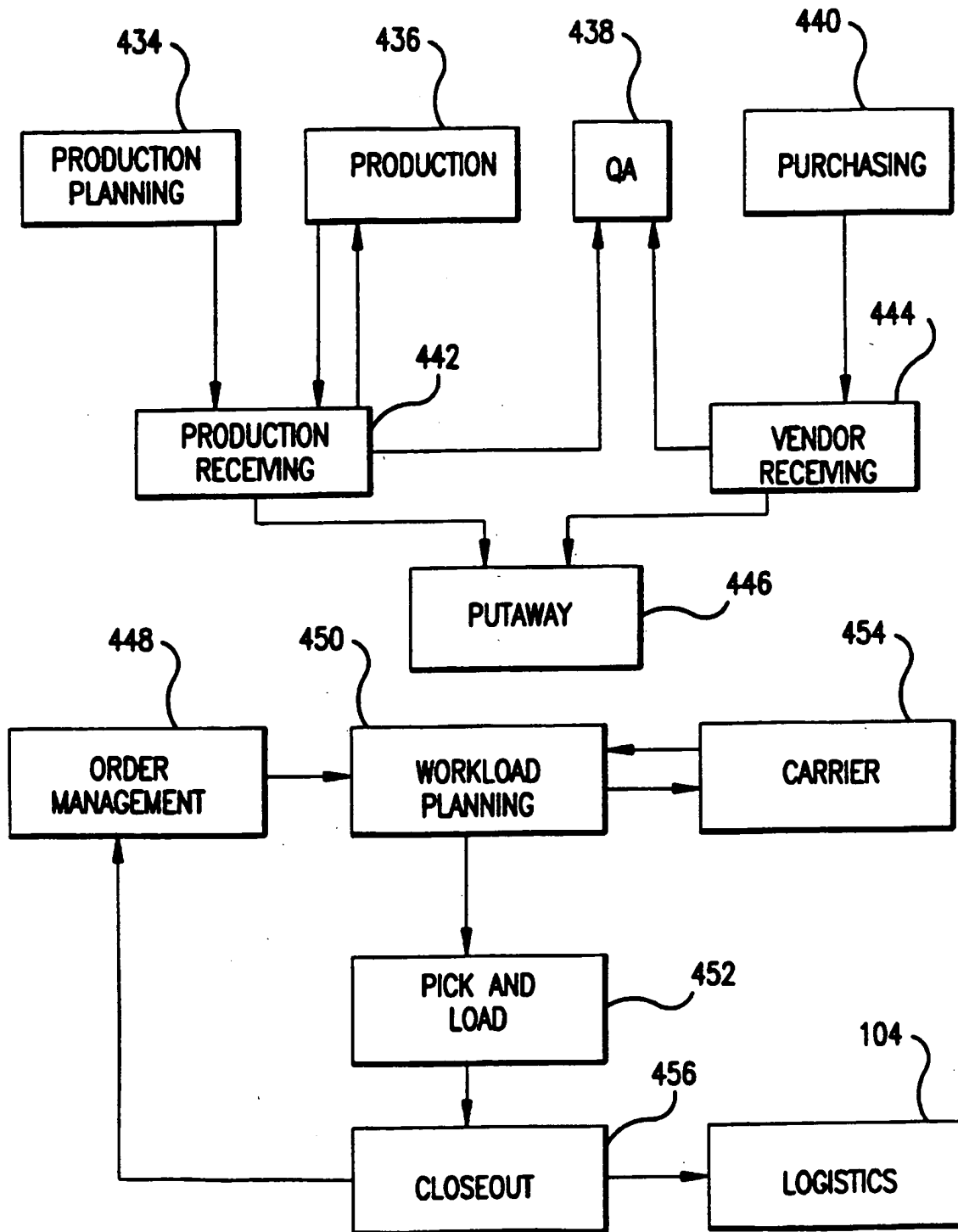

FIG.24



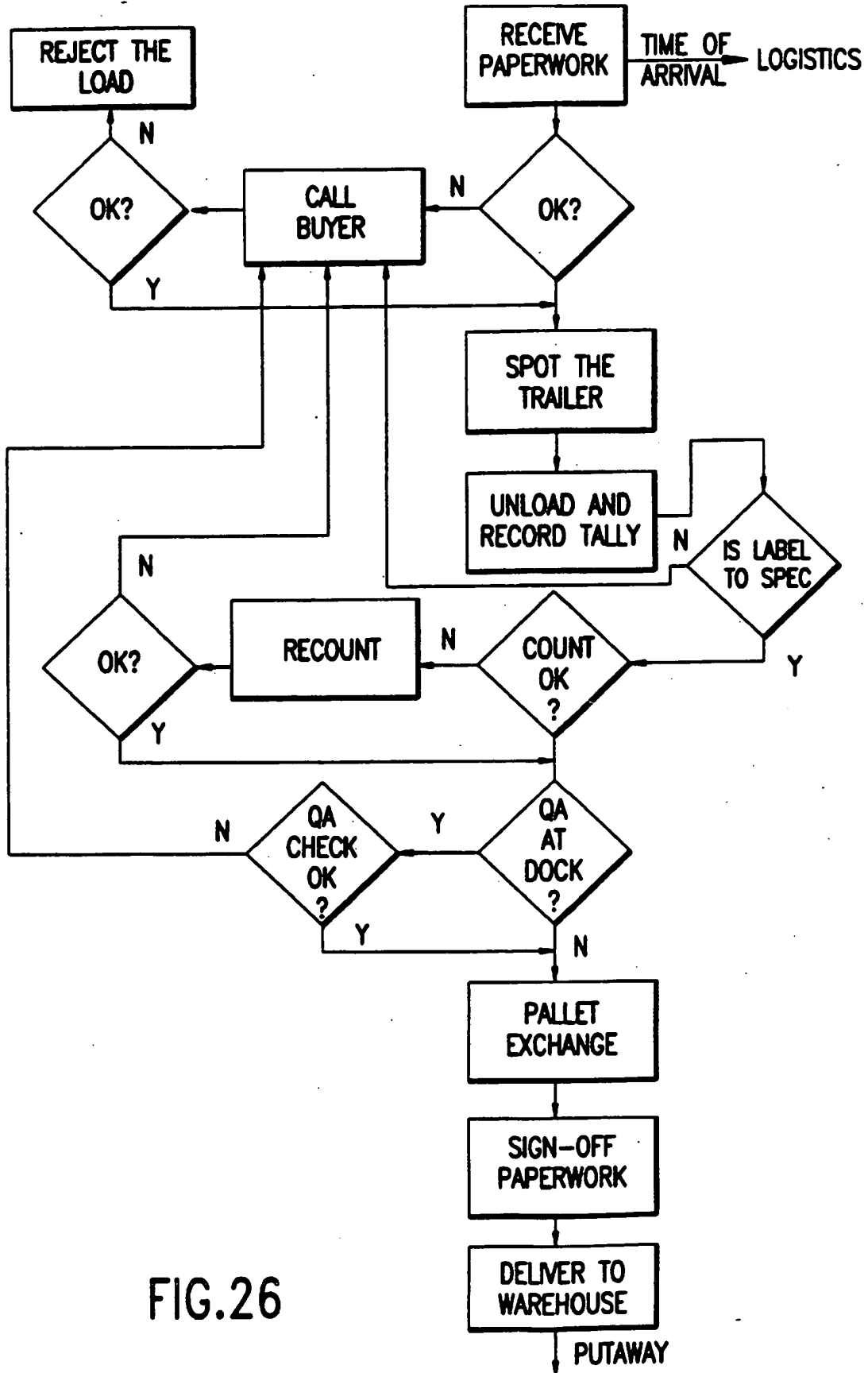

FIG.26

66000 " T 000000

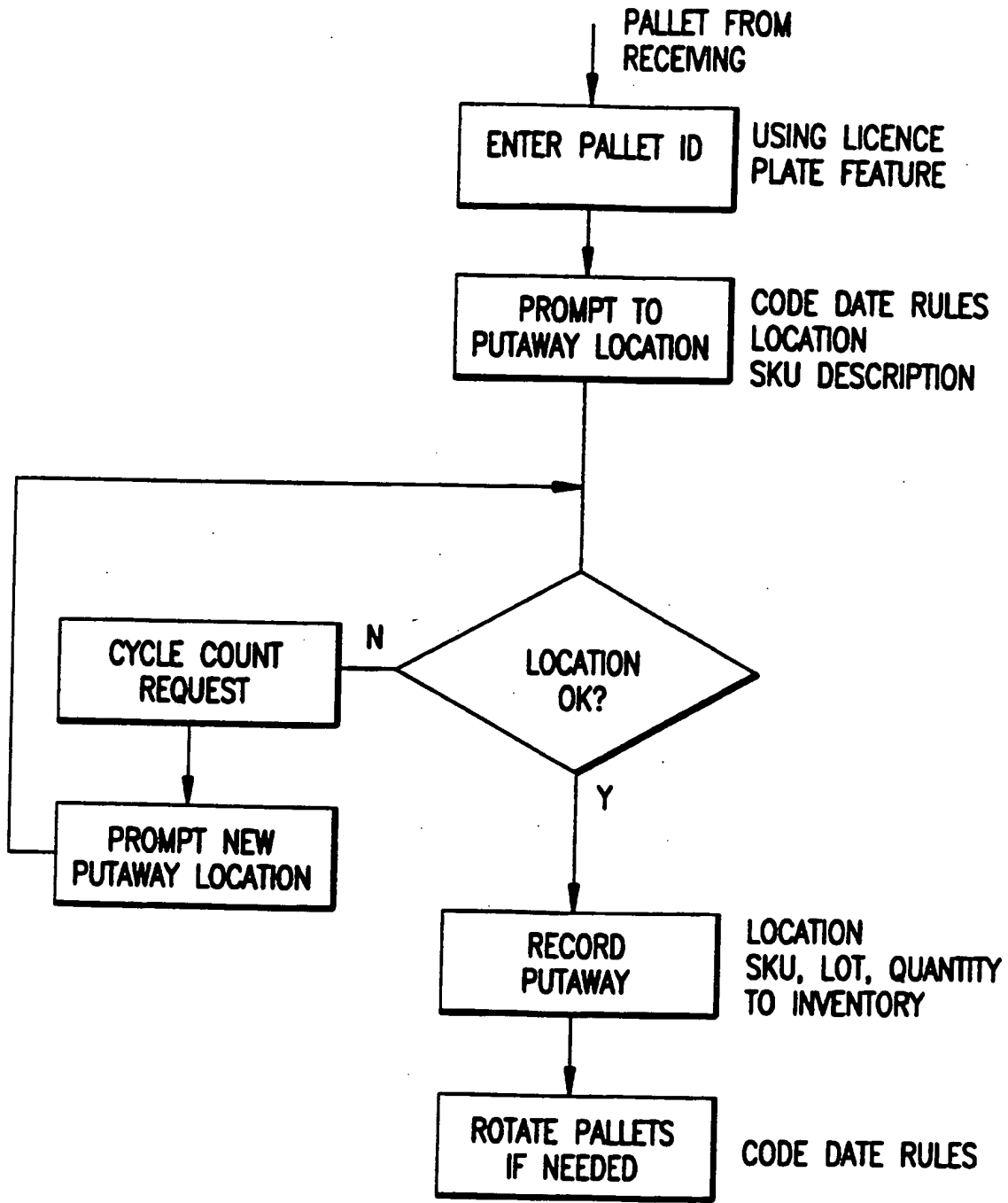

FIG.27

# WORKLOAD PLANNING

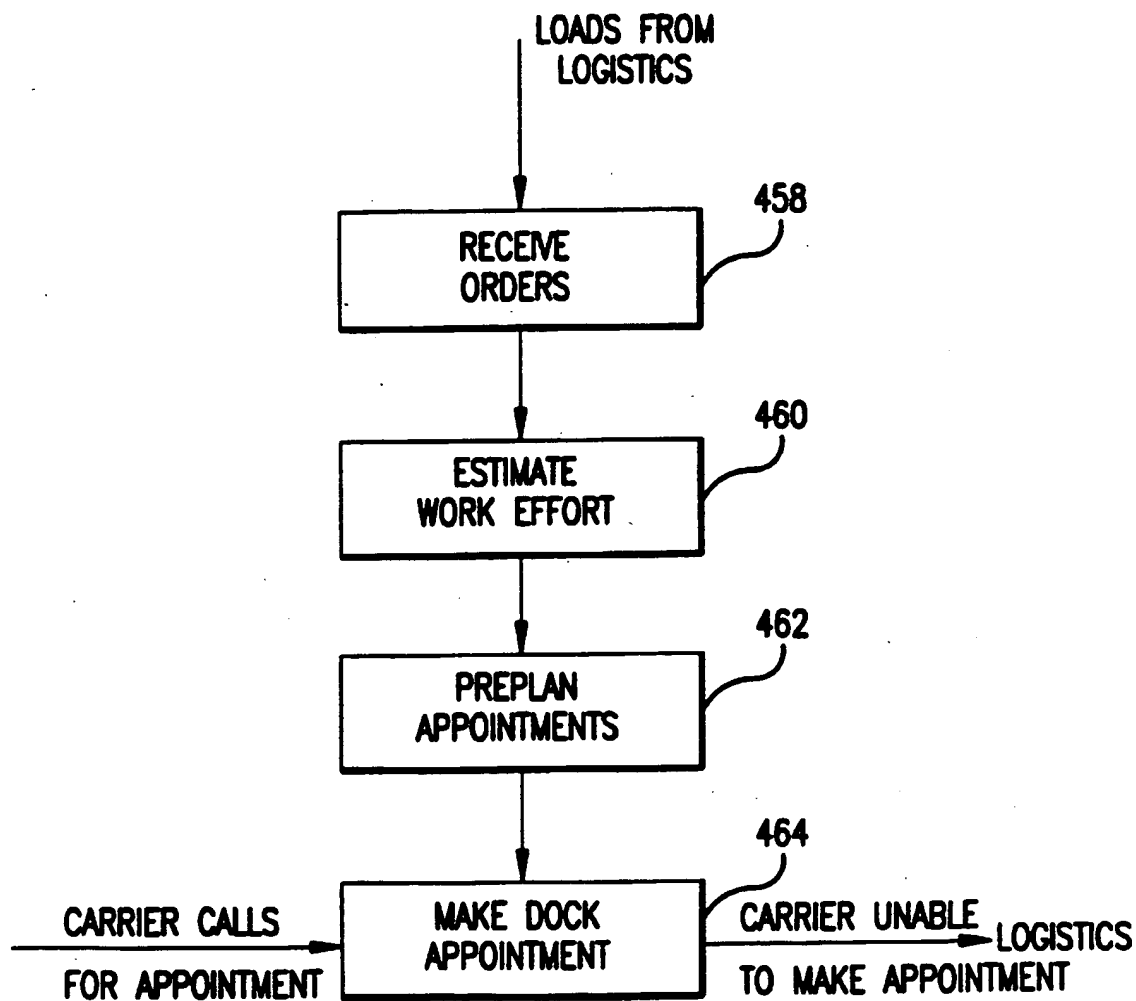

FIG.28

# ORDER PICK

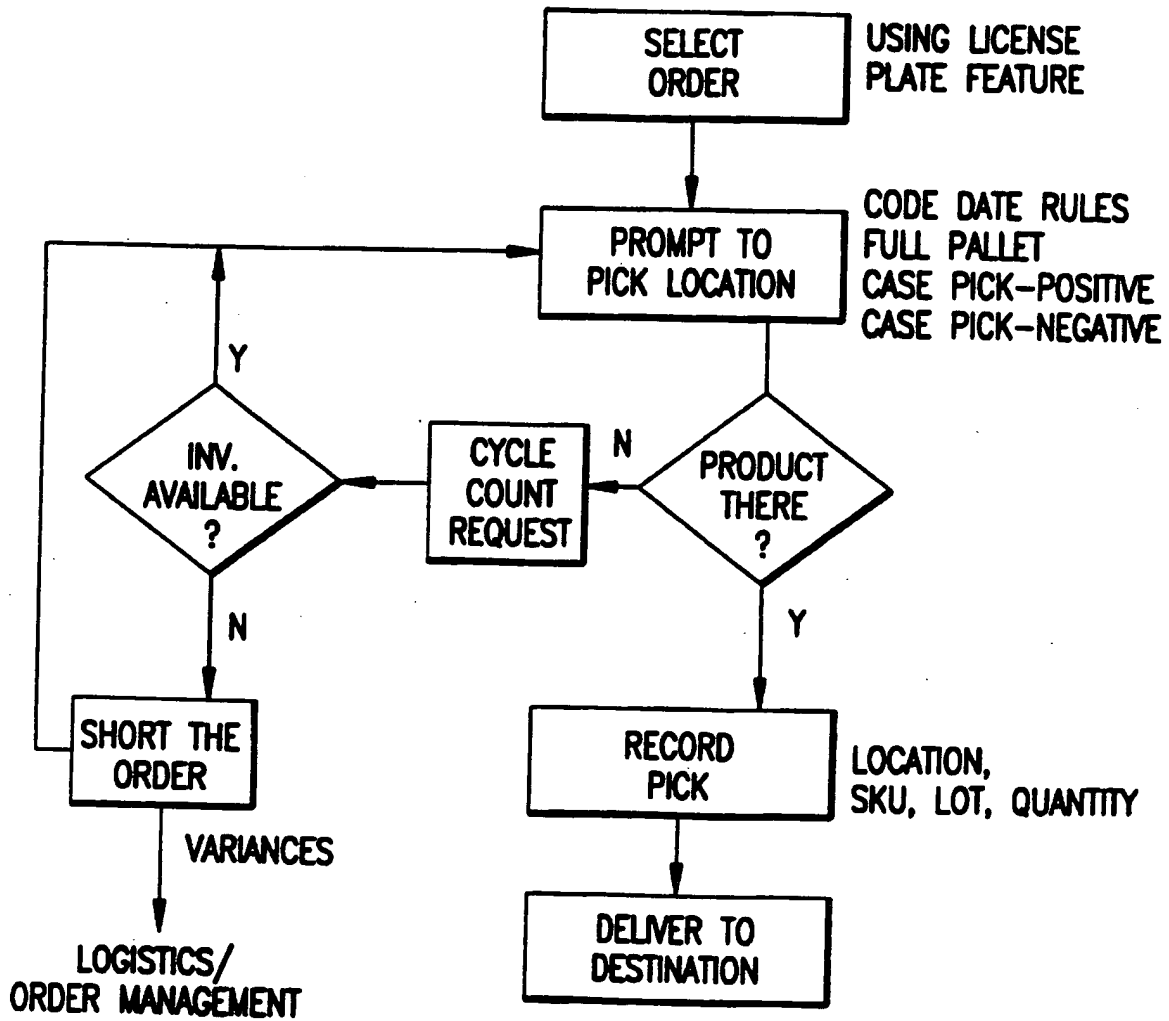

FIG.29





# ORDER LOAD AND CLOSEOUT

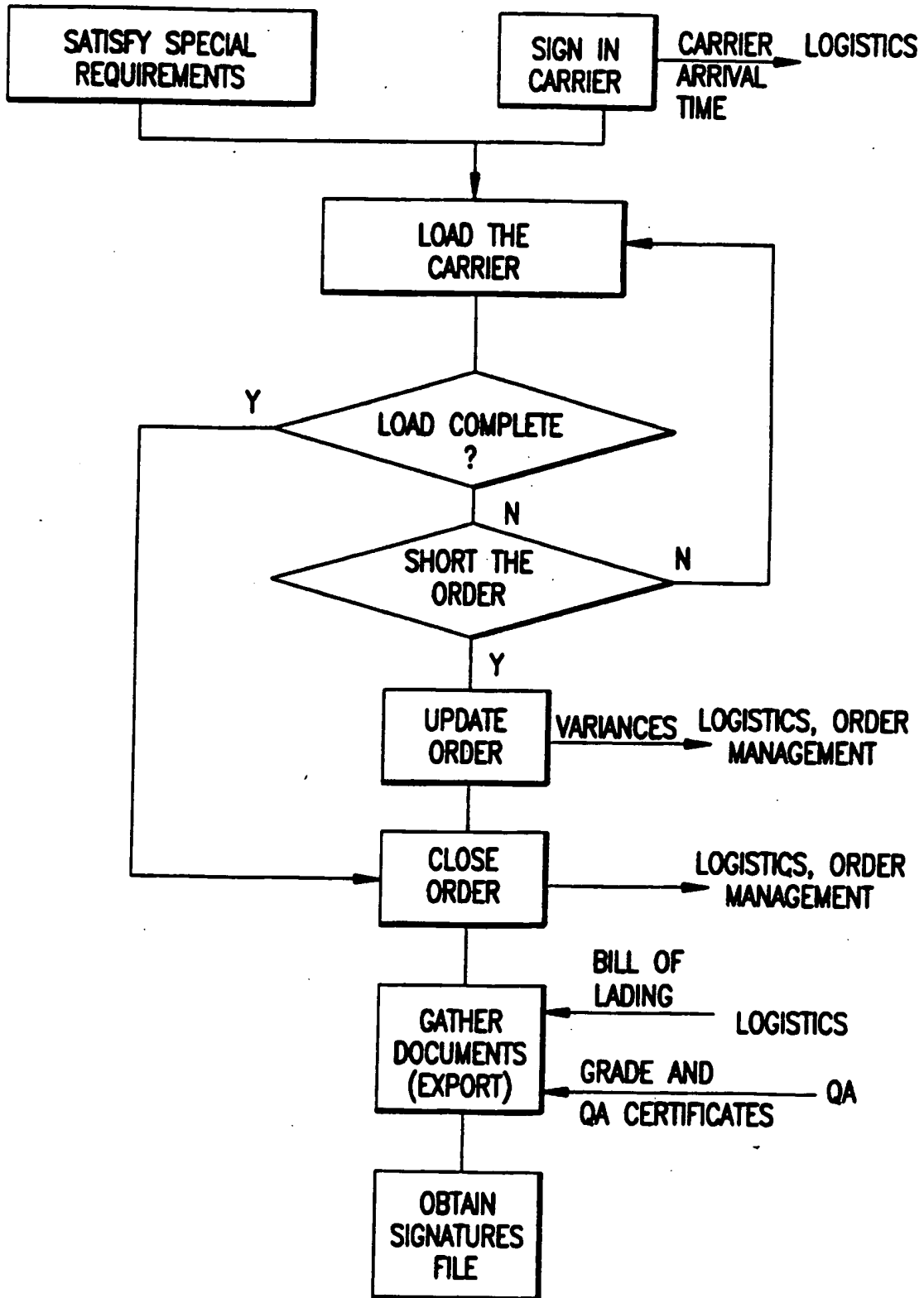

FIG.31

CYCLE COUNT

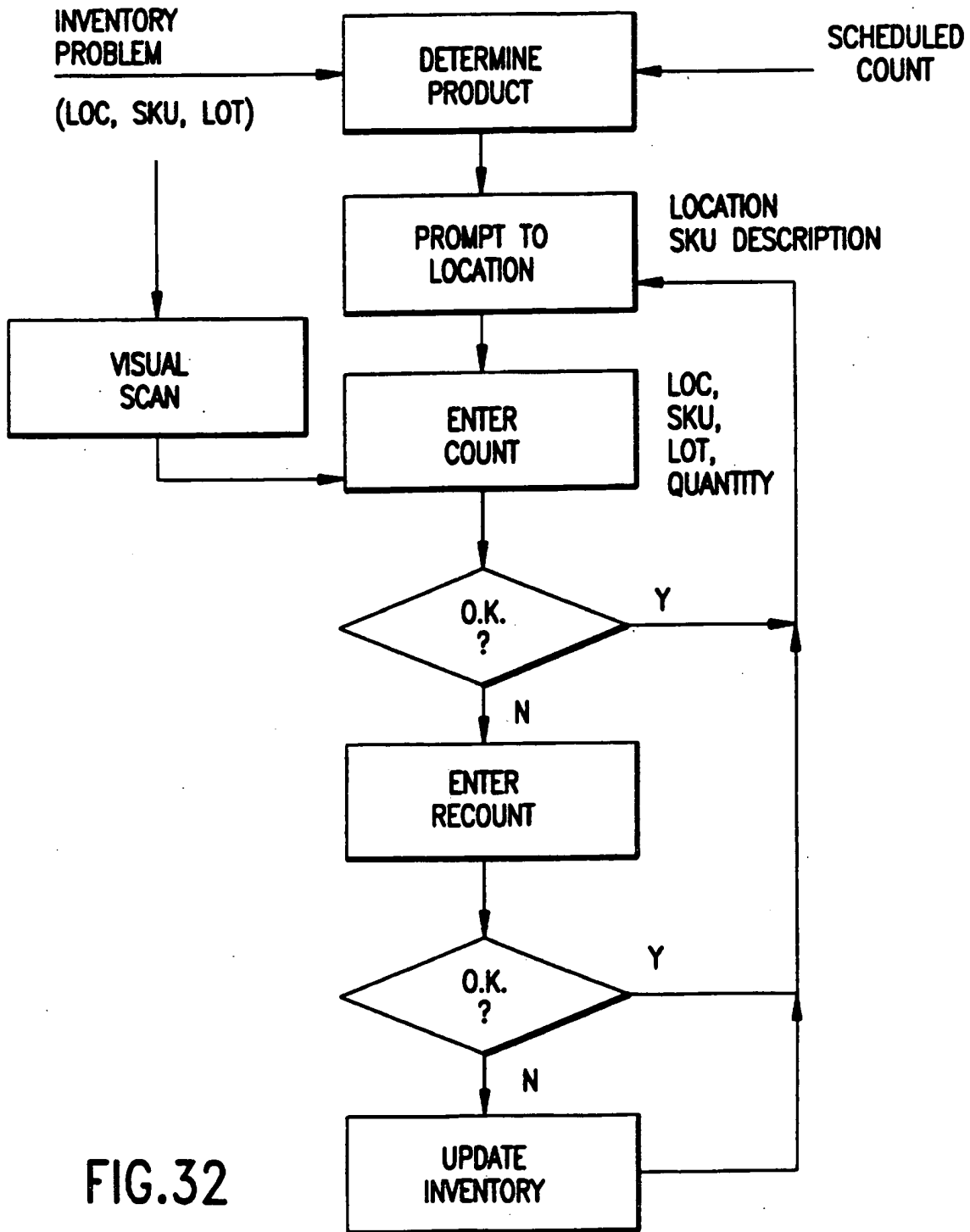

FIG.32



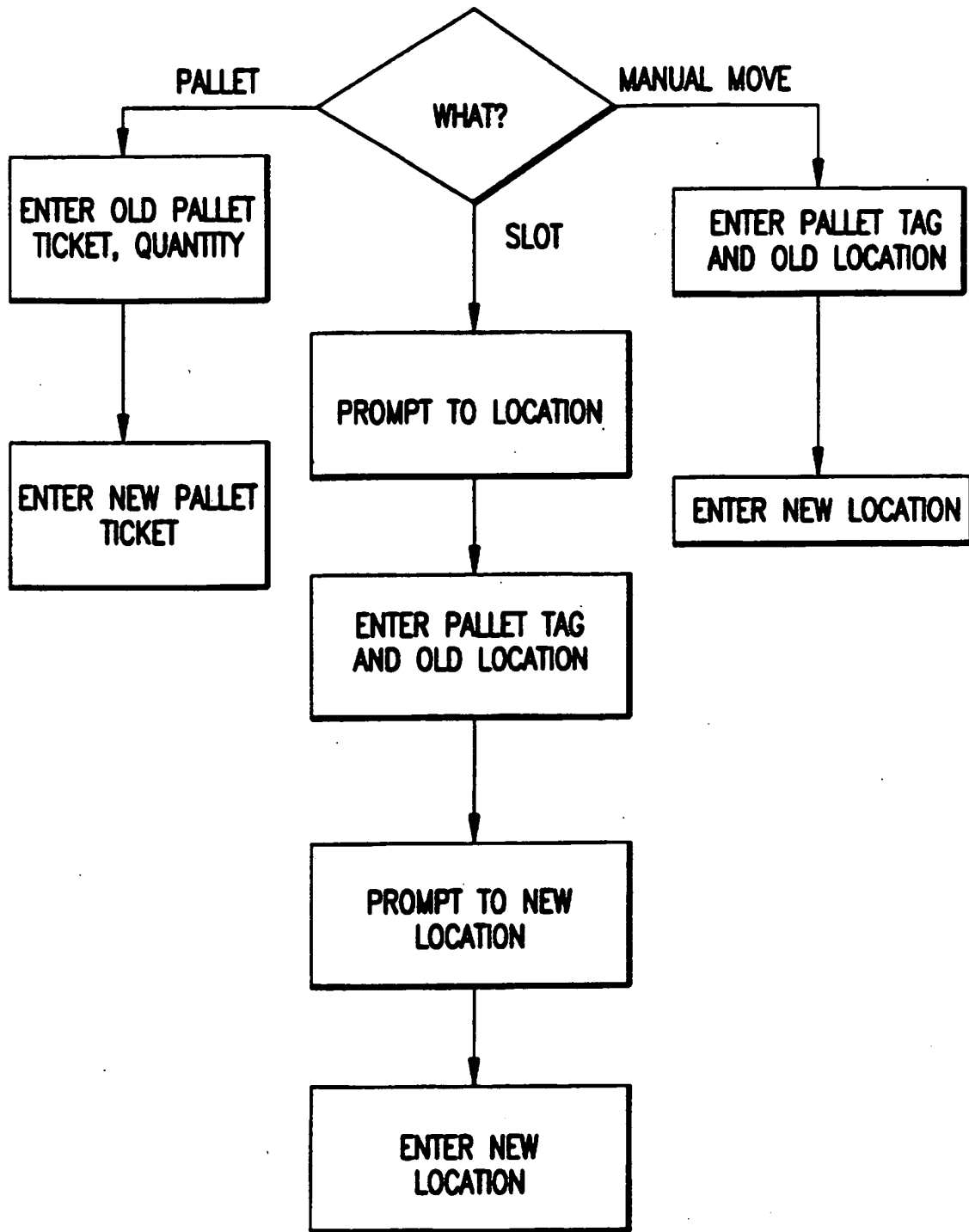

FIG.34

RETURNS

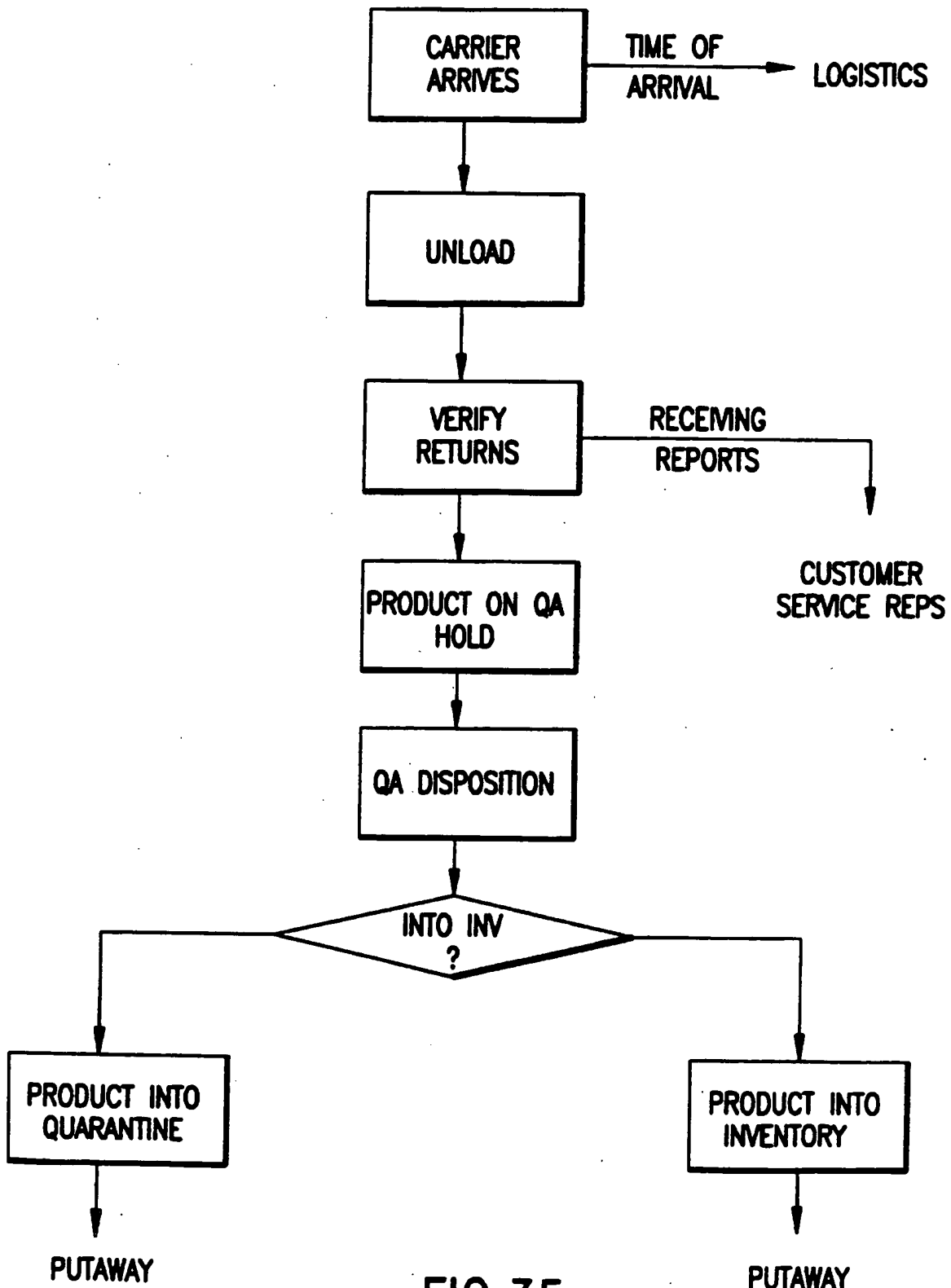

FIG.35

OUTSIDE STORAGE

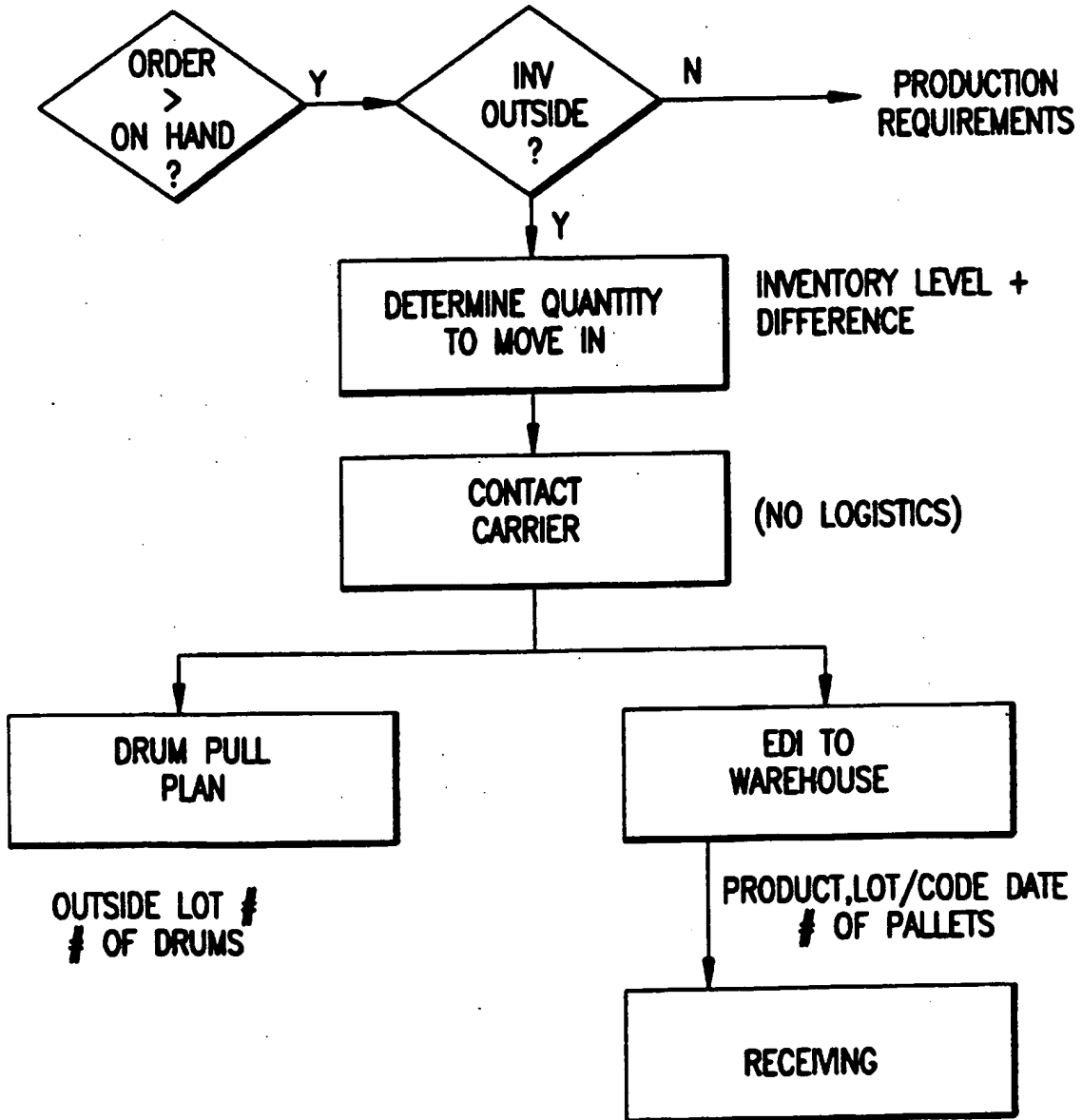

FIG.36

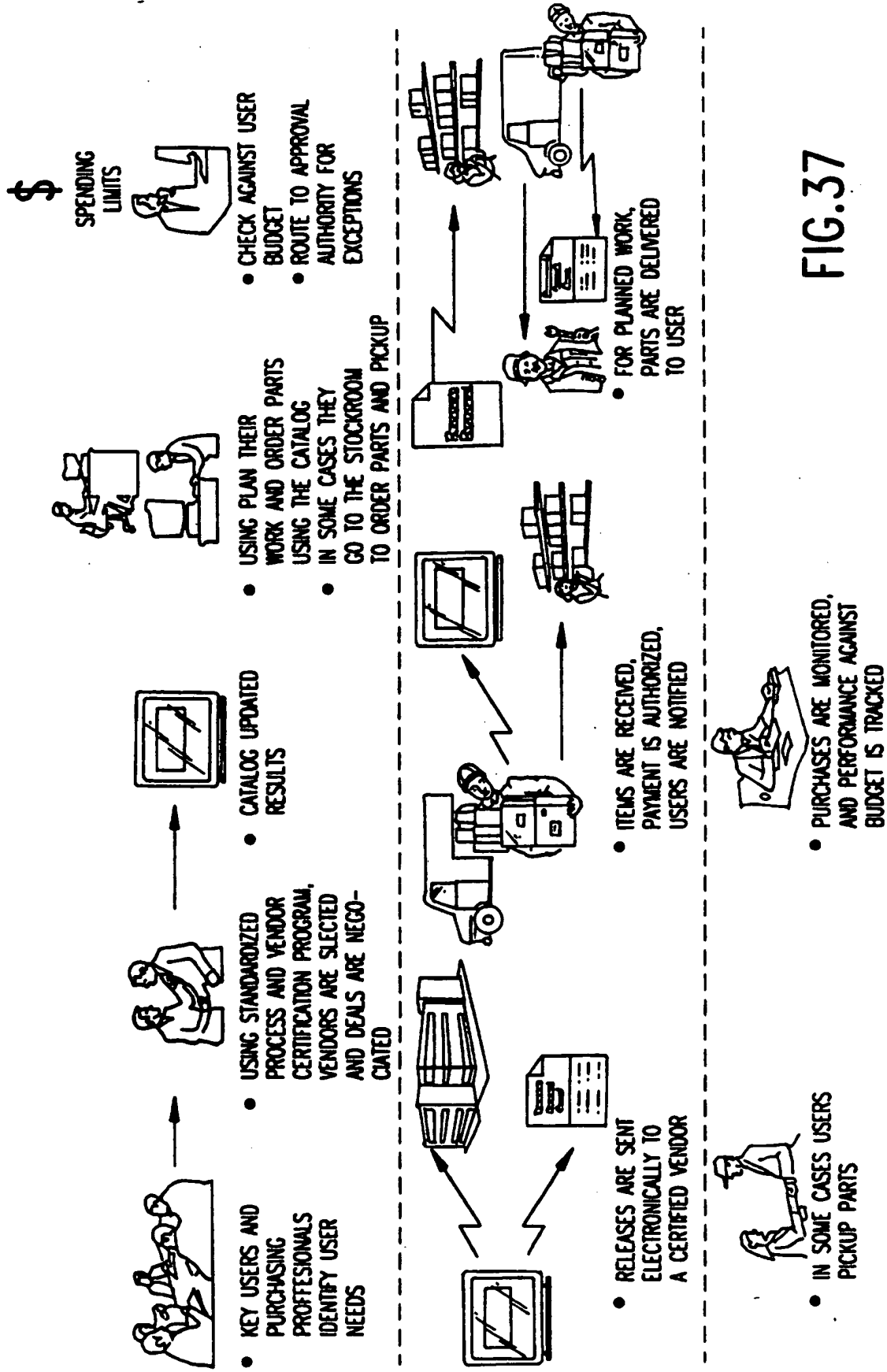

FIG.37

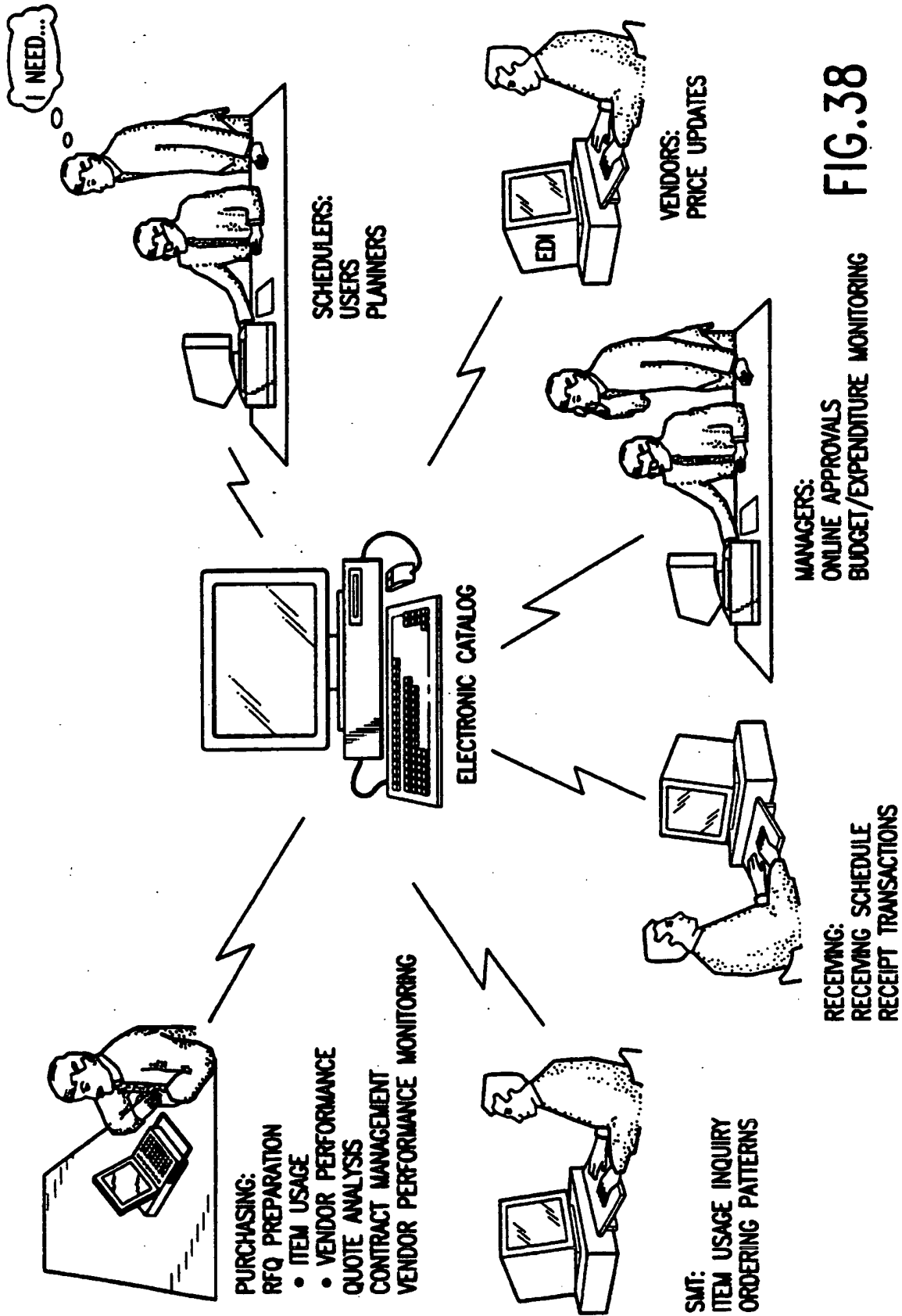

FIG.38



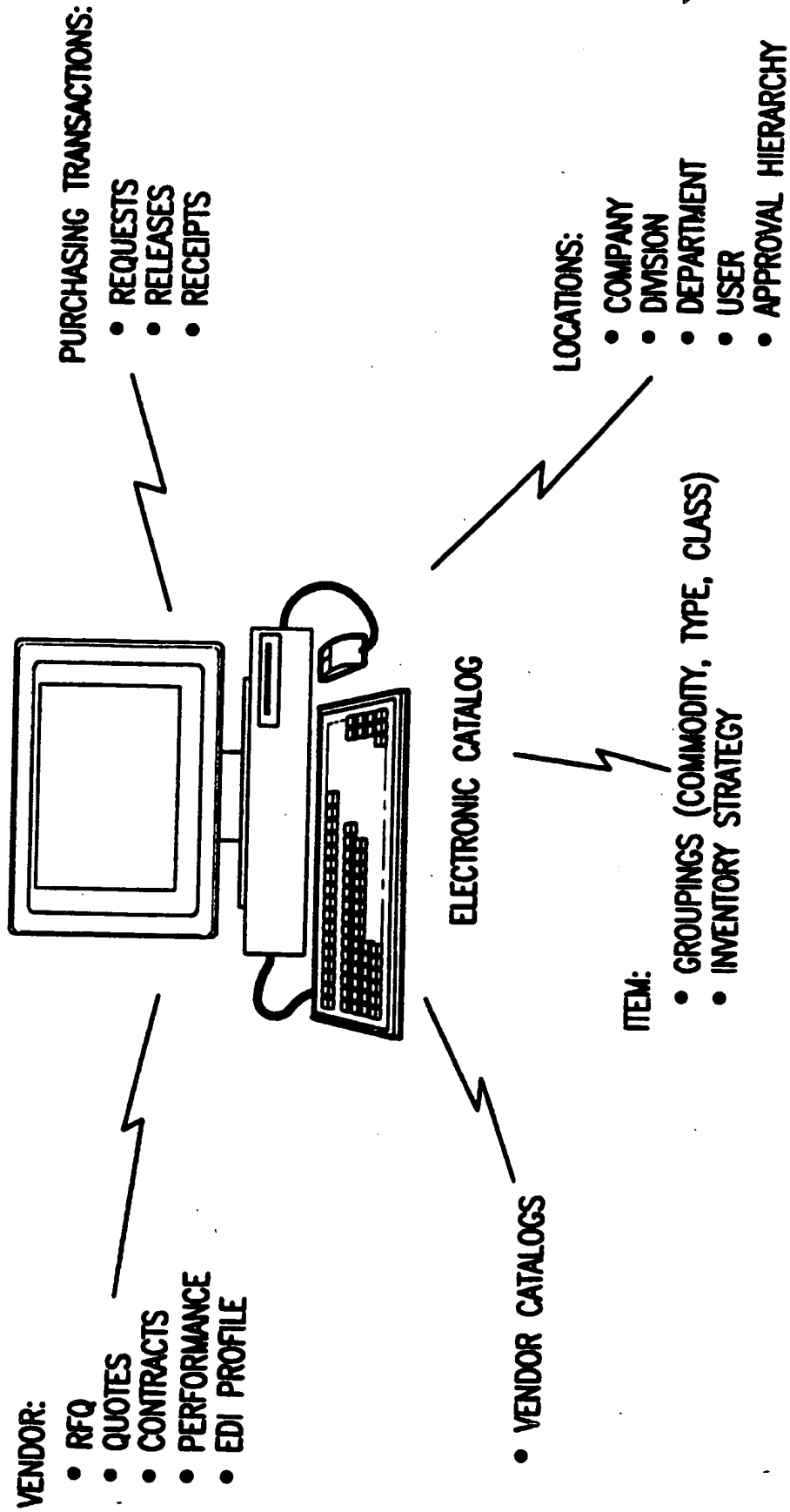

FIG.39

